

Print ISSN: 2436-293X Online ISSN: 2436-2956



GHM Open

Global Health & Medicine Open

Volume 3, Number 1
August, 2023

www.ghmopen.com

GHM Open

GHM Open (Print ISSN 2436-293X, Online ISSN 2436-2956) is an international, open-access, peer-reviewed journal, published by the National Center for Global Health and Medicine (NCGM), which is a national research and development agency in Japan that covers advanced general medicine, basic science, clinical science, and international medical collaboration. It is published by NCGM and supported by the International Research and Cooperation Association for Bio & Socio-Sciences Advancement (IRCA-BSSA).

1. Mission and Scope

GHM Open is dedicated to publishing high-quality original research that contributes to advancing global health and medicine, with the goal of creating a global information network for global health, basic science as well as clinical science oriented for clinical application.

The articles cover the fields of global health, public health, and health care delivery as well as the seminal and latest research on the intersection of biomedical science and clinical practice in order to encourage cooperation and exchange among scientists and healthcare professionals in the world.

2. Manuscript Types

GHM Open publishes Original Articles, Brief Reports, Reviews, Policy Forum articles, Study Protocols, Case Reports, Communication, Editorials, Letters, and News.

3. Editorial Policies

GHM Open will perform an especially prompt review to encourage submissions of innovative work. All original research manuscripts are to be subjected to an expeditious but rigorous standard of peer review, and are to be edited by experienced copy editors to the highest standards.

We aspire to identify, attract, and publish original research that supports advances of knowledge in critical areas of global health and medicine.

Editor-in-Chief

Norihiro Kokudo, M.D., Ph.D.
President,
National Center for Global Health and Medicine;
Professor Emeritus,
The University of Tokyo.

Editorial and Head Office

GHM Open
National Center for Global Health and Medicine,
1-21-1 Toyama Shinjuku-ku, Tokyo 162-8655, Japan
URL: www.ghmopen.com
E-mail: office@ghmopen.com

Associate Editors

Masayuki Hojo
Tokyo

Tatsuya Kanto
Tokyo

Hong-Zhou Lu
Shenzhen

Wataru Sugiura
Tokyo

Yukihito Ishizaka
Tokyo

Takashi Karako
Tokyo

Tetsuro Matano
Tokyo

Guido Torzilli
Milan

Office Director & Executive Editor

Peipei Song
Tokyo

Editorial Board

Daniele Del Fabbro
Milan

Yukio Hiroi
Tokyo

Norio Ohmagari
Tokyo

Yasuhide Yamada
Tokyo

Nermin Halkic
Lausanne

Takeshi Inagaki
Tokyo

Shinichi Oka
Tokyo

Hidekatsu Yanai
Chiba

Kiyoshi Hasegawa
Tokyo

Akio Kimura
Tokyo

Fabio Procopio
Milan

Kojiro Ueki
Tokyo

Hiroshi Obara
Tokyo

Nobuyuki Takemura
Tokyo

Advisory Board

Nobuyoshi Aoyanagi
Tokyo

Hiroaki Mitsuya
Tokyo

Haruhito Sugiyama
Tokyo

(As of August 2021)

POLICY FORUM

- 1-6 **Seven steps in the value chain of health products for equitable access and delivery in low- and middle-income countries.**
Eiichi Shimizu, Yuta Yokobori, Kazuki Miyazaki, Kaori Ohara, Megumi Fujii, Tomoko Nishioka, Noriko Fujita

REVIEW

- 7-19 **Association of adipokines with insulin resistance and metabolic syndrome including obesity and diabetes.**
Abhishek Gupta, Priyanka Gupta, Arun Kumar Singh, Vani Gupta

ORIGINAL ARTICLE

- 20-27 **Using eConsent to improve patient comprehension and solving issues for introduction, with special attention to the COVID-19 pandemic: A questionnaire survey by the Japan Pharmaceutical Manufacturers Association.**
Naoki Tomotsugu, Naoki Sakuma, Maki Dobashi, Miki Someya, Akiko Imai, Junichi Sakoda, Masashi Fukuda, Katsuhiko Yoshimoto, Tatsuo Iiyama
- 28-36 **Alpha and Delta variants and vaccination effectiveness against severity in COVID-19 inpatients based on medical claims in Japan.**
Shingo Mitsushima, Hiromasa Horiguchi, Kiyosu Taniguchi

BRIEF REPORT

- 37-41 **Visualization of aerosol spread using a smoke tester during tracheal intubation performed in an operating room.**
Kohshi Hattori, Asako Eriguchi, Mayuko Omori, Osamu Nagata
- 42-46 **Clinical features of cervical cancer at a national cancer center in Phnom Penh, Cambodia: A descriptive cross-sectional study.**
Aya Tanaka, Linka Koun, Rei Haruyama, Kyna Uy, Maryan Chhit, Lumpiny Kim, Noriko Fujita, Yutaka Osuga, Tadashi Kimura, Kanal Koum

CASE REPORT

- 47-50 **Psychodynamic therapy for adverse childhood experience in a hospitalized girl with attention deficit hyperactivity disorder.**
Kaori Sugimoto, Toshinari Kurokouchi, Rena Shinohara, Yuuki Sakoh, Maiko Odaka, Hikaru Sunakawa, Shuichi Tanese, Manao Seto, Masahiro Ishida, Yuta Yoshimura, Kotoe Itagaki, Ikuhiro Harada, Saori Inoue, Yuki Hakoshima, Kumi Inazaki, Yuki Mizumoto, Masahide Usami
- 51-55 **Pulmonary sclerosing pneumocytoma: A potential pitfall mimicking lung adenocarcinoma.**
Himani Rai, Ipsita Dhal, Zachariah Chowdhury, Swapnil Patel, Durgatosh Pandey

CONTENTS

(Continued)

LETTER

- 56-57** **Global vaccine equity: The G7's commitment and challenges.**
Yudai Kaneda, Kenzo Takahashi, Akihiko Ozaki, Tetsuya Tanimoto

Seven steps in the value chain of health products for equitable access and delivery in low- and middle-income countries

Eiichi Shimizu*, Yuta Yokobori, Kazuki Miyazaki, Kaori Ohara, Megumi Fujii, Tomoko Nishioka, Noriko Fujita

Bureau of International Health Cooperation, National Center for Global Health and Medicine, Tokyo, Japan.

Abstract: The introduction of health products to low- and middle-income countries (LMICs) is hindered by several barriers. Even when these barriers are overcome, improper use of health products can have a negative effect on health outcomes. Health products may go unused due to a mismatch of product needs as well as a lack of public infrastructure, spare parts and consumables, or trained technicians. This study presents a comprehensive framework of the essential steps for effectively delivering quality health products to people in need based on our document reviews and case studies. We divide the value chain of health products into seven steps: 1) situation analysis, 2) research and development, 3) regulatory authorization, 4) selection and prioritization, 5) public procurement, 6) distribution and storage, and 7) health service delivery. We find that the practice of undertaking one step at a time leads to enormous costs in terms of time and resources, often with little success. Failed attempts sometimes necessitate starting over from the beginning. Therefore, it is important to attempt each step while looking ahead to the end through the entire chain of seven steps. More in-depth analysis and lessons from best practices for each of the seven steps may need to be investigated further to consider possible interventions.

Keywords: access and delivery, health products, developing countries, medical devices, universal health coverage

Introduction

As Goal 3 of the Sustainable Development Goals states, "access to quality essential healthcare services and access to safe, effective, quality and affordable essential medicines and vaccines for all" are critical to achieving universal health coverage (UHC) (1). Nevertheless, many low- and middle-income countries (LMICs) lack access to quality vaccines, medicines and medical devices (hereafter "health products"), health technologies, and health services (2), a situation that impacts the health of the population.

One reason for this challenge is that health products are not always delivered in a manner appropriate for the country (3). In addition, improper use of health products can have a negative impact on health outcomes (4). Health products may go unused due to a mismatch of product needs as well as a lack of public infrastructure, spare parts and consumables, or trained technicians (5).

Equitable delivery of health products and services is becoming more complex due to pharmaceutical regulations and geographic disparities, as seen in the delivery of vaccines and related supplies for countering COVID-19 (6,7). LMICs have limited access to safe and high-quality health products and must rely heavily on donor support, exceeding 80% of supply in some cases

(8). In LMICs where regulatory authorization is weakly functioning, public procurement is a major means to secure access to and delivery of safe and affordable health products (9).

Several conceptual frameworks exist but there is no universal framework for effectively improving access to and delivery of health products in LMICs (10). Thus, this study attempts to create a series of steps that correspond to the existing value chain of health products by conducting a document review and case studies.

The following three cases describe the experiences of the National Center for Global Health and Medicine (NCGM; Tokyo, Japan) in promoting access to and delivery of health products in LMICs. Each case is presented in the order of context, actions, outcomes, and lessons learned. Based on these cases, we propose a comprehensive framework for describing characteristics, with a view to enhance access to and delivery of health products in LMICs.

Case 1. Development of health products for LMICs

Working in hospitals and health centers in LMICs, we have often observed situations where health products, manufactured in high-income countries and provided by international agencies, were kept unused. In some cases,

products were never distributed from central storehouses. For those that were distributed to health facilities, many went unused or unopened because they did not suit the local context and actual needs.

To ensure safe and quality health products are used appropriately and continuously in LMICs, NCGM, as part of advising the provision of health products by Japanese grant aid and other Official Development Assistance (ODA) agencies, launched a program in 2016 called "Supporting business plan of Medical Equipment Development for Overseas based on local needs" (SMEDO) with funding from the Tokyo Metropolitan Government (11). The program targets small and medium-sized Japanese manufacturers aiming to develop health products for LMICs, helping them to increase their understanding of the on-the-ground reality through lectures and site visits to health facilities in Vietnam and Cambodia. Manufacturers also receive expert advice on financing and business plans for overseas deployment.

The needs for health products vary from country to country due to country-specific factors such as the educational and technical level of the health workforce, economic conditions, the health insurance system, infrastructure development, lifestyles, and customs. Through visits to facilities where their products are actually used, manufacturers can better understand the actual needs of the local health workforce, how equipment is maintained, and local business customs and distribution methods.

Through this program, participating manufacturers found that LMICs need low-cost, easy-to-use, and easy-to-maintain products, leading them to reconsider subsequent product development. This case demonstrates the importance of conducting situational analyses of local contexts and actual needs and incorporating the results in the research and development (R&D) of health products for use in LMICs.

Case 2: Installation of radiological equipment in Zambia

In 2015, the Zambian Ministry of Health purchased computed tomography (CT) and interventional radiology (IVR) equipment for the University Teaching Hospital (UTH) in order to improve the treatment of cardiovascular disease (CVD). However, the hospital staff lacked the training to operate the equipment and it went unused. Consequently, UTH continued to send patients in need of testing and treatment to health institutions in neighboring countries.

Because the equipment was manufactured by a Japanese company, UTH requested that NCGM provide technical support to their physicians, radiology technologists, and nurses involved in diagnosing and treating CVD. From 2017 to 2019, NCGM provided hands-on technical assistance, including not only how to use the equipment but also how to make the best use

of the equipment in medical procedures. In addition, NCGM established an equipment management system and provided comprehensive in-service training, including radiation protection, to ensure provision of safe healthcare. The training also covered "Setsugu" (12), Japanese-style patient hospitality.

Subsequently, under the supervision of the NCGM team, the UTH team successfully performed Zambia's first coronary CT in February 2018, coronary angiography (CAG) and percutaneous coronary angiography (PCI) in November 2019. In addition, the number of CT scans performed at the hospital increased by 129.6% from 2017 to 2019 (13). However, an unexpected CT equipment failure in 2019 prevented us from performing coronary CT. In response to this, UTH signed a maintenance contract with the manufacturer for its sustainable use. Consumables such as stents and catheters are needed to perform CAG and PCI; thus, a distribution system for these supplies was established between UTH and local distributors.

This case study yields three lessons from the perspectives of access and delivery. First, the capacity of the local health workforce should be evaluated when delivering equipment. It is important to determine whether there are enough trained technicians to operate the equipment. If not, it will be necessary to provide training. Second, it is important to ensure proper equipment management, including daily inspections and regular maintenance. Third, the introduction of new technologies might necessitate the procurement of consumables that were not previously required.

Case 3. Introduction of health products for blood safety in Myanmar

From 2005 to 2015, NCGM and the Ministry of Health and Sports (MOHS) in Myanmar worked together to improve blood transfusion services in Myanmar. Then, to further improve the quality and safety of blood transfusions for advanced therapies such as transplantation, NCGM and the Myanmar National Blood Center (NBC) launched a new four-year project in collaboration with Japanese medical equipment manufacturers in 2015 (14).

In this project, an infectious disease control advisor from NCGM coordinated between Japanese doctors, nurses, and laboratory technicians and Myanmar government officials and the NBC. The Japanese team visited the NBC and local hospitals to understand the local conditions. Recognizing the need for further safety improvements, the Japanese team provided training to local doctors, laboratory technicians, and nurses in blood typing and clinical transfusion therapy. Simultaneously, Japanese manufacturers provided equipment and consumables, including refrigerators for blood packs, centrifuges for component blood preparation, and leukocyte filters.

High-ranking officials from the Myanmar government and the NBC visited Japan to learn about the Japanese blood transfusion system. To improve safety, an annual blood transfusion seminar for policymakers and clinicians was launched in Myanmar in collaboration with the NBC. Furthermore, the infectious disease control advisor assisted with the creation of Myanmar's national blood transfusion guidelines. Through these activities, Japanese blood transfusion-related products were procured and distributed by the MOHS.

This case exemplifies technical cooperation that met local needs and led to successful product procurement. First, the relationship of trust fostered by long-term cooperation with MOHS and the NBC made it possible to perform a more practical situation analysis that led to technology transfers and training as well as R&D of products that reflected actual needs. Second, involving stakeholders facilitated coordination within the MOHS, enhancing awareness of the importance of safety. Consequently, Japanese products were procured by the Myanmar government. Third, providing appropriate training in collaboration with the NBC improved service quality and led to nationwide product distribution. Finally, Japanese manufacturers shifted their mindset toward investing in the future, illustrating an effective marketing strategy for expanding overseas.

Framework of essential steps for better access to and delivery of health products

By reviewing the barriers and success factors in the above cases, we concluded that the entire value chain can be divided into seven steps to accelerate equitable access to and delivery of health products in LMICs:

1) situation analysis, 2) research and development, 3) regulatory authorization, 4) selection and prioritization, 5) public procurement, 6) distribution and storage, and 7) health service delivery (Figure 1). Below, we describe the characteristics of each step.

Step 1. Situation analysis

This step involves thorough market research to identify the end users, their needs, the circumstance in which the intended product would be used, and prices in the existing market. Critical questions include *i)* Can health products be distributed to rural clinics? *ii)* What is the status of infrastructure such as water, electricity and telecommunications? *iii)* What is the maintenance capacity of local suppliers and service providers who use health products? *iv)* What testing and medication costs are affordable for residents? *v)* What health issues are specific to the region? And *vi)* What are the projections for demographic characteristics, emerging diseases, socioeconomic status, and so on? It is also important to study competing products and examine related trends. The SMEDO and Myanmar cases illustrated situational analyses that led to effective interventions. In contrast, the Zambia case demonstrated an inadequate analysis of the situation regarding trained technicians capable of accurately using and managing the product.

Step 2. Research and development (R&D)

In this step, it is important to find appropriate partners that can help collect data and verify the utility of the product in LMICs. Some manufacturers may take advantage of the financial and technical support

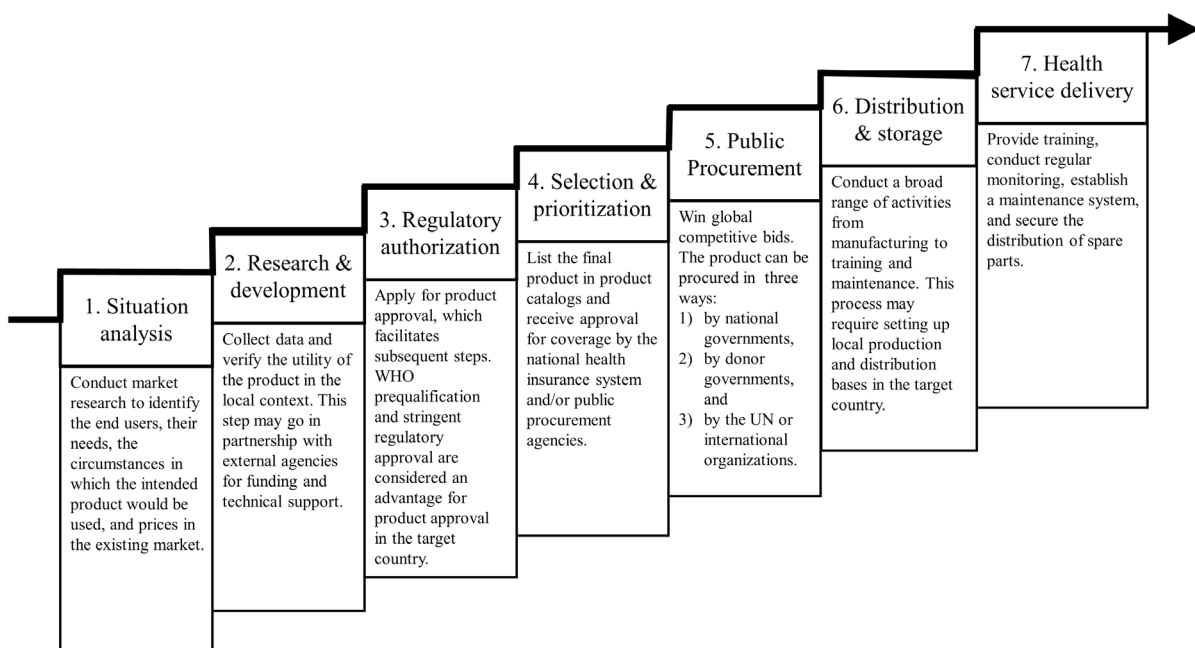

Figure 1. Seven steps for equitable access to and delivery of health products. This framework represents the entire value chain of health products divided into seven steps. The characteristics of each step are described in the box below.

provided by academia, international organizations, and governments as they design and develop products suitable for LMICs. In the case of Myanmar, the Japanese team collaborated with the NBC from the beginning, and the Japanese manufacturer was able to obtain the necessary information to adapt its products to local conditions.

Step 3. Regulatory authorization

The World Health Organization (WHO) and national governments use their regulatory authority to assure the safety and quality of health products. This step involves confirming the WHO's prequalification and obtaining national regulatory approval in the target country. Manufacturers can apply for product approval, which facilitates subsequent steps, especially Steps 4 and 5. However, this time-consuming and costly step requires strategic planning (15). The abovementioned activities in Myanmar were influential in obtaining regulatory authorization. High-ranking government officials were involved in the training and therefore played a crucial role in the public procurement of Japanese products because they understood their necessity and practical applications.

Step 4. Selection and prioritization

Obtaining product approval does not necessarily mean the product should be selected for local usage. This step involves efforts to list the final product in product catalogs and to be covered by the national health insurance plan of the target government. National governments may require a track record of sales results in different countries and examples of product use on English-language websites. Among approved products, those that should be used at the local health facility level will tend to be prioritized. In some countries, a health technology assessment is conducted for selection and price-setting (16). In the Myanmar case, the national transfusion guidelines created through the project indicated the need for quality and safety standards. Because the products met those standards, they were selected and prioritized.

Step 5. Public procurement

This step can occur in three ways: *i*) direct procurement by national governments in LMICs, sometimes with funding provided by international organizations (or procured by international organizations on behalf of the government); *ii*) procurement by donor governments for the purpose of assisting LMICs; and *iii*) procurement by United Nations agencies or other international organizations for the purpose of supporting LMICs. Challenges for manufacturers include establishing an adequate supply chain for mass production and setting

affordable prices to win global competitive bids. Products that are already pre-qualified by the WHO and listed in global product catalogs have an advantage. In the case of Myanmar, the government directly procured the products. The Japanese manufacturer's shift toward investing in the future was an essential component of cultivating the target country's market.

Step 6. Distribution and storage

This step refers to the entire supply chain in the provision of products and services. This involves a broad range of activities from manufacturing including local production, distribution, and storage, to user training and maintenance. Manufacturers may need to set up local production and distribution bases in the target country. In the case of Myanmar, the NBC coordinated the nationwide distribution of the products. In the case of Zambia, the ability to provide a new kind of examination service led to increased demand for consumables, which opened up further sales opportunities.

Step 7. Health service delivery

To deliver and maintain health products locally, it is essential to provide local technicians with proper training and guidance. It is also helpful to establish a maintenance system, secure distribution of spare parts, and provide a monitoring system to receive feedback from local health facilities. In Myanmar, provision of practical training improved the quality of service, while the involvement of stakeholders facilitated the creation of national guidelines. The Zambia case suggested the importance of keeping maintenance contracts and user training.

Perspectives in setting a universal framework for access and delivery

There are several existing conceptual frameworks that describe the factors related to access to and delivery of health products in LMICs. The United Nations proposed a pharmaceutical value chain, from the development of medicines to their appropriate use by patients, to ensure access to safe, effective, and quality-assured medicines, including controlled medicines (17). This framework is characterized by the "Manufacturing" step and by dividing "Health service delivery" into several practical steps, which were modified by the WHO to expand the focus to health products as a whole, with post-marketing surveillance added at the end (18). In addition, the UN Development Programme Access and Delivery Partnership (UNDP-ADP) suggested another framework of steps to help manufacturers deliver health products to people in need (19). As shown in Table 1, these frameworks are similar to ours in that they cover the steps from R&D to health service delivery. However, there are some differences, including "Situation

Table 1. Comparison of relevant frameworks for access to and delivery of health products

Items	NCGM 7 steps	UNDP-ADP	UN pharmaceutical value chain	WHO value chain of health products
Target	Health products	Health products	Medicines	Health products
Number of steps	7	6	8	9
Steps				
Situation analysis	① Situation analysis			
R&D	② R&D	① New medicines, vaccines, diagnostics	① R&D and innovation	① R&D and innovation
Manufacturing	*Included in step ⑥		② Manufacturing	② Manufacturing
Accreditation	③ Regulatory authorization	② Regulatory authorization	③ Marketing registration	③ Marketing registration
Selection	④ Selection and prioritization	③ Selection, prioritization and resource allocation	④ Selection/pricing/reimbursement	④ Selection/pricing/reimbursement
Procurement	⑤ Public procurement	④ Public procurement	⑤ Procurement and supply	⑤ Procurement and supply
Distribution	⑥ Distribution and storage	⑤ Storage and distribution		
Service provision	⑦ Health service delivery	⑥ Health service delivery	⑥ Prescribing, ⑦ Dispensing, and ⑧ Use	⑥ Prescribing, ⑦ Dispensing, and ⑧ Use
Monitoring				⑨ Post market surveillance

*NCGM seven steps include "Manufacturing" in step of ⑥ Distribution and storage. NCGM, National Center for Global Health and Medicine; UNDP-ADP, United Nations Development Programme Access and Delivery Partnership; R&D, Research and development.

analysis," which was incorporated into our framework as the first step.

As stated in Cases 1 and 2, better understanding of local conditions is needed to ensure access to and delivery of health products to people in need in LMICs in order to achieve UHC. In particular, the following perspectives should be considered at the "Situation analysis" step: the distribution system of health products to local health facilities; the status of basic infrastructure, including water, electricity, and telecommunications; the maintenance capacity of local suppliers; the affordability of services for local people; and compatibility with local needs and demographic prospects. Although the "R&D" step in other frameworks may include the investigation of local conditions, our framework places more emphasis on "Situation analysis," which is the first and most important step in supporting access to and delivery of health products in LMICs. By analyzing local needs, it might be possible to modify existing health products for local markets without a long and costly R&D process.

In addition, analyzing the needs of marginalized and vulnerable populations can facilitate the promotion of equitable access to healthcare in light of UHC. For example, mobile X-ray equipment is a good example of how a product developed for home healthcare in Japan was adapted for use in remote settings, leading to market expansion and better access for disadvantaged populations in LMICs (20). No matter how innovatively products are developed, if they do not contribute to mediating health equity issues, they will only create health disparities.

Our seven-step approach serves as a road map for a diverse range of stakeholders by clarifying core principles at each step in the value chain and services to be delivered to the population, with the aim of realizing UHC. However, further research is required to strengthen the evidence base for accurate conceptualization of the

topic. For example, our framework does not include a "Manufacturing" step, which is incorporated into the "Distribution and storage" step instead. This is because we developed our framework based mainly on our experience that manufacturing was included in a series of activities by manufacturers under distribution and storage. However, the location, method, and cost of manufacturing are important aspects in the value chain of health products. Therefore, it remains to be determined whether the "Manufacturing" step should be emphasized more in our framework.

Lastly, our framework incorporates several activities into the "Health service delivery" step. In contrast, the UN has three separate steps ("Prescribing," "Dispensing," and "Use"), while the WHO added "Post market surveillance" as the final step after health service delivery. The need to monitor the progress of access to and delivery of health products should also be investigated in future research. We wish to explore more case studies in order to identify challenges and lessons learned in addressing how best each step should take place in the deliberation of accessible health products in LMIC settings.

Conclusion

Our goal should be to provide people in LMICs with equitable access to safe, affordable, and reliable products that are suitable for local conditions and needs, with the aim of improving health outcomes. Instead of a narrow approach that aims only to achieve WHO prequalification or product approval, it is important to view the entire value chain of health products comprehensively, following the seven steps proposed in this article. Such a comprehensive, forward-thinking perspective would be helpful in ensuring that the end user is always considered. Our seven-step approach offers considerations that may

be useful for all stakeholders involved in access to and delivery of health products. The approach will also contribute to improving global health disparities.

Acknowledgements

The authors would like to thank Drs. Masahiko Hachiya, Yuriko Egami, Masami Fujita, Mari Nagai, and Shinsuke Miyano as well as our colleagues who supported the work of the Bureau of International Health Cooperation at NCGM to promote access to and delivery of health products in LMICs by providing insight and technical expertise, which greatly assisted this research.

Funding: This work was supported by a research grant from the Ministry of Health, Labour and Welfare (MHLW) of Japan (Grant No. 21BA1001).

Conflict of Interest: The authors have no conflicts of interest to disclose.

References

1. The United Nations. Sustainable development goals. Goal 3: Ensure healthy lives and promote well-being for all at all ages. <https://www.un.org/sustainabledevelopment/health/> (accessed September 9, 2022).
2. Compton B, Barash DM, Farrington J, Hall C, Herzog D, Meka V, Rafferty E, Taylor K, Varghese A. Access to medical devices in low-income countries: addressing sustainability challenges in medical device donations. NAM Perspectives. Discussion Paper, National Academy of Medicine, Washington, DC. <https://doi.org/10.31478/201807a> (accessed September 9, 2022).
3. Malkin RA. Barriers for medical devices for the developing world. *Expert Rev Med Devices*. 2007; 4:759-763.
4. World Health Organization. Everybody's business: strengthening health systems to improve health outcomes: WHO's framework for action. <https://apps.who.int/iris/handle/10665/43918> (accessed September 9, 2022).
5. Diaconu K, Chen YF, Cummins C, Jimenez Moyao G, Manaseki-Holland S, Lilford R. Methods for medical device and equipment procurement and prioritization within low- and middle-income countries: findings of a systematic literature review. *Global Health*. 2017; 13:59.
6. Wakabayashi M, Ichimura Y, Shimizu E, Nishioka T, Kono Y, Doi M, Egami Y, Kadowaki T, Iso H, Fujita N. Global extension of Japanese medical products related to COVID-19: a survey of WHO Emergency Use Listing. *GHM Open*. 2022; 2:59-62.
7. World Health Organization. Assessment of the COVID-19 supply chain system: full report. <https://www.who.int/publications/m/item/assessment-of-the-covid-19-supply-chain-system-report> (accessed September 9, 2022).
8. World Health Organization. Medical devices: managing the mismatch. https://apps.who.int/iris/bitstream/handle/10665/44407/9789241564045_eng.pdf (accessed September 9, 2022).
9. World Health Organization. The Global Health Observatory - Procurement of medical devices carried out at the national level. <https://www.who.int/data/gho/data/indicators/indicator-details/GHO/procurement-of-medical-devices-carried-out-at-the-national-level> (accessed September 9, 2022).
10. Kuupiel D, Bawontuo V, Drain PK, Gwala N, Mashamba-Thompson TP. Supply chain management and accessibility to point-of-care testing in resource-limited settings: a systematic scoping review. *BMC Health Serv Res*. 2019; 19:519.
11. Tokyo Metropolitan Government. Supporting business plan of medical equipment development for overseas based on local needs. <https://smedo.tokyo/english.html> (accessed September 9, 2022).
12. Shimada H. Consideration of patient care from point of view of radiological technologist. *Iryo*. 2007; 61:26-29. (in Japanese)
13. Kono Y, Shimizu E, Matsunaga F, Egami Y, Yoneda K, Sakamoto K, Mubita M, Sichizya VS, Wakamatsu K, Terashima M, Fujita N. Enhancing the use of computed tomography and cardiac catheterization angiography in Zambia: A project report on a global extension of medical technology in Japan. *Glob Health Med*. 2021; 3:52-55.
14. Nozaki I, Aung T, Oo NN, Kodoi H, Ito Y, Inaba T, Shiratori K. Enhancing the blood safety program in Myanmar: Report on projects of global extension of medical technologies of Japan. *Glob Health Med*. 2021; 3:48-51.
15. Vaz A, Roldão Santos M, Gwaza L, Mezquita González E, Pajewska Lewandowska M, Azatyan S, Saint-Raymond A. WHO collaborative registration procedure using stringent regulatory authorities' medicine evaluation: reliance in action? *Expert Rev Clin Pharmacol*. 2022; 15:11-17.
16. Oortwijn W, Broos P, Vondeling H, Banta D, Todorova L. Mapping of health technology assessment in selected countries. *Int J Technol Assess Health Care*. 2013; 29:424-34.
17. The United Nations. The pharmaceutical value chain. <https://syntheticdrugs.unodc.org/syntheticdrugs/en/access/pharmaceutical/index.html> (accessed September 9, 2022).
18. World Health Organization. Realizing equitable global access interfaces between public health, innovation and intellectual property. https://www.wipo.int/edocs/mdocs/mdocs/en/wipo_who_wto_gc_covid_19_21/wipo_who_wto_gc_covid_19_21_3.pdf (accessed September 9, 2022).
19. The Access and Delivery Partnership. Strengthening national health systems. <https://adphealth.org/strengthening-national-health-systems/> (accessed September 9, 2022).
20. National Center for Global Health and Medicine. Learning from domestic and overseas cases on the global expansion of medical products: development, regulatory approval, and global public procurement. https://kyokuhp.ncgm.go.jp/library/tenkai/2021/tenkai-seminar202203_light.pdf (accessed September 9, 2022). (in Japanese)

Received September 9, 2022; Revised October 13, 2022; Accepted October 19, 2022.

Released online in J-STAGE as advance publication November 4, 2022.

*Address correspondence to:

Eiichi Shimizu, Bureau of International Health Cooperation, National Center for Global Health and Medicine, 1-21-1 Toyama, Shinjuku-ku, Tokyo 162-8655, Japan.
E-mail: eshimizu@it.ncgm.go.jp

Association of adipokines with insulin resistance and metabolic syndrome including obesity and diabetes

Abhishek Gupta^{1,*}, Priyanka Gupta², Arun Kumar Singh^{1,5}, Vani Gupta^{1,5}

¹Department of Physiology, King George's Medical University, Lucknow, India;

²Department of Medicine, King George's Medical University, Lucknow, India.

Abstract: Adipose tissue (AT) acts as a highly active endocrine organ, which secretes a wide range of adipokine hormones. In the past few years, several adipokines (leptin, adiponectin, resistin *etc.*) have been discovered showing metabolic consequences in relation to insulin resistance (IR), obesity and diabetes. These adipokines are considered to be an important component playing an important role in the regulation of energy metabolism. They have been shown to be involved in the pathogenesis of metabolic syndrome (MetS) and cardiac diseases. The current article provides a holistic summary of recent knowledge on adipokines and emphasizes their importance in association with IR, obesity, diabetes and MetS. Adipokines such as leptin, adiponectin, resistin and tumor necrosis factor-alpha (TNF- α) have been involved in the regulation of an array of metabolic functions and disease associated with it, *e.g.* appetite and energy balance of the body, suppression of atherosclerosis and liver fibrosis, obesity with type 2 diabetes (T2D) and IR. An important adipokine, Interleukin-6 (IL-6), also correlates positively with human obesity and IR and also the elevated level of IL-6 predicts development of T2D. All of these hormones have important correlation with energy homeostasis, glucose and lipid metabolism, cardiovascular function and immunity. All the possible connections have extended the biological emphasis of AT secreted adipokines as an investigator in the development of MetS, and are now no longer considered as only an energy storage site.

Keywords: adipose tissue, lipid, glucose, appetite, homeostasis

Introduction

Metabolic syndrome (MetS) is a constellation of interconnected physiological and biochemical abnormalities characterized by high fasting glucose, abnormal cholesterol and triglyceride levels, hypertension, central obesity and many more (1). MetS is a widely distributed disorder present in 20-25% of the world's adult population. Many factors such as genetic, environmental, metabolic and others contribute to the development of MetS (2). Kim *et al.* demonstrated the role and associated mechanisms of adipokines in the development of MetS (3), but mechanisms remain controversial and require further research to open unexplored metabolic pathways. One of the most accepted classifications for defining MetS is the Third Report of the National Cholesterol Education Program (NCEP) Expert Panel on Detection, Evaluation and Treatment of High Blood Cholesterol in Adults (Table 1) (4). Obesity is a well-recognized risk factor for the development of insulin resistance (IR) and MetS. An increase in total body fatness and preferential upper body accumulation of fat tissue is independently related to IR. Obesity with a greater proportion of upper body fat tissue

tends to be more insulin resistant, hyperinsulinemic, glucose intolerant and dyslipidemic than obesity with a greater proportion of lower body fat. So, the distribution of body fat tissue is an important correlate of MetS.

Due to the dramatic rise in obesity and associated metabolic abnormalities worldwide, research pertaining to, adipose tissue (AT) has gained tremendous scientific interest for several years. Previous research demonstrated that AT acts in an autocrine, paracrine or endocrine reservoir to control various metabolic functions and may contribute to the development of obesity mediated MetS. AT secretes various proteins or factors with diverse functions termed as bioactive mediators or "adipokines" (previously designated as "adipocytokines") modulating hemostasis, blood pressure, lipid and glucose metabolism, inflammation, and atherosclerosis (Table 2). In 2004, Trayhurn and Wood proposed an integrative term, "adipokinome", which, together with the lipid moieties released and adipokines constitute the "secretome" of fat cells (5). These adipokines secreted from adipocytes are defined as insulin antagonists (TNF- α , IL-6 and Resistin) and insulin sensitizers (Leptin and Adiponectin) (Figure 1) (6). These adipokines may act locally or distally to alter insulin sensitivity in insulin-targeted organs such

Table 1. Criteria for clinical diagnostic of the MetS

No.	Obesity		Dyslipidemia		Blood pressure	Glucose	Insulin resistance	Others
	Diagnosis	Male	Female	Male				
1.	NCEP-ATP III (≥ 3 of any criteria), 2001	Abdominal obesity WC ≥ 102 cm or 40 inches	Abdominal obesity WC > 88 cm or 36 inches	TG ≥ 150 mg/dl HDL-C < 40 mg/dl or on therapy	≥ 130/85 mmHg or on therapy	Fasting Glucose > 110 mg/dl (≥ 6.1 mmol/L)	—	—
2.	WHO (5th or 6th + ≥ 2 of any criteria), 1999	WHR > 0.90 and/or BMI > 30 Kg/m ²	WHR > 0.85 and/or BMI > 30 Kg/m ²	TG ≥ 150mg/dl (≥ 1.7 mmol/L) HDL-C < 35 mg/dl (≤ 0.9 mmol/L)	≥ 140/90 mmHg	IFG, IGT	IR measured under hyperinsulinaemic-euglycemic conditions	Urinary albumin excretion rate ≥ 20 µg/min or albumin: creatinine ratio ≥ 30 mg/g min
3.	EGIR (5th + ≥ 2 of any criteria), 1999	WC ≥ 94 cm	WC ≥ 80 cm	TG ≥ 177mg/dl (≥ 2.0 mmol/L) HDL-C < 39 mg/dl (< 1.0 mmol/L)	≥ 140/90 mmHg or on medication	Fasting Glucose IR > 110 mg/dl (≥ 6.1 mmol/L)	—	—
4.	AHA/ NHLBI or Updated NCEP criteria, 2005	WC ≥ 102 cm (Asian ≥ 90) or 40 inches	WC > 88 cm (Asian ≥ 80) or 36 inches	TG ≥ 150mg/dl (≥ 1.7 mmol/L) HDL-C < 40 mg/dl (1.0 mmol/L) or on therapy	≥ 130/85 mmHg or on medication	Fasting Glucose > 100 mg/dl (5.6 mmol/L)	—	—
5.	IDF (1st + ≥ 2 of any criteria), 2005	Waist circumference ≥ 90 cm for men and ≥ 80 cm for women) for Asian Indian subjects	Waist circumference ethnic specific	TG ≥ 150 mg/dl (≥ 1.7 mmol/L) HDL-C < 40 mg/dl (1.03 mmol/L) or on therapy	≥ 130/85 mmHg or on therapy	Fasting Glucose > 100 mg/dl (5.6 mmol/L) or DM	—	—

MetS, metabolic syndrome; NCEP ATPIII, National Cholesterol Education Program-Adult Treatment panel III; WHO, World Health Organization; EGIR, European Group of Insulin Resistance; AHA/NHLBI, American Heart Association/Normal Heart, Lung, and Blood Institute; IDF, International Diabetes Federation; WC, waist circumference; WHR, waist to hip ratio; BMI, body mass index; SBP, systolic blood pressure; DBP, diastolic blood pressure; TC, total cholesterol; HDL, high density lipoprotein; TG, triglyceride; LDL, low density lipoprotein; VLDL, very low density lipoprotein; FPG, fasting plasma glucose; FPI, fasting plasma insulin; HOMA-IR, homeostatic model assessment-insulin resistance; DM, diabetes mellitus.

as muscle and liver or may act through neuro-endocrine, autonomic or immune pathways. This disequilibrium between pro and anti-inflammatory adipokines induces low-grade inflammation, associated mainly with adiposity and IR. In this regard, it is known that increased adiposity is a major determinant of IR and that altered adipokine regulation is the underlying reason.

Several of these adipokines are interdependent, and the crosstalk among themselves may play an important role in the pathophysiology and management of MetS (7). In this review article, our focus is on major adipokines, the interplay between adipokines, and tries to ascertain their role in MetS with the current state of information

available and how they may influence insulin sensitivity.

Adipokines, IR and central obesity

There is a close relationship between IR, central/visceral adiposity and adipokines (Figure 2). IR is associated with an overabundance of metabolic risk factors such as abnormal elevated cholesterol or lipids, high blood pressure, body functional inabilities, low level of inflammation, dysregulated adipokine production and many of these can either alone or jointly speedup the atherogenic process and malfunctioning of glucose metabolism. IR should be conceptualized in a very broad manner that takes into account the interplay between nutrition, insulin and adipokines in various tissues of metabolic importance. IR correlates with the degree of obesity (visceral obesity) and is a strong predictor of the development of T2D.

In 1988, it was hypothesized that IR is a contributory central component of MetS or syndrome X. Insulin action impaired in AT causes increased lipolysis and release of free fatty acid (FFA). The increased flux of FFA not only impairs insulin secretion by pancreatic islet β-cells, but also induces IR by interfering with glucose transport and insulin-mediated glucose uptake in muscle and liver. Adipokines appear to play a central role and plasma levels may serve as candidate biomarkers for mediating both the MetS of IR and the endothelial dysfunction in obesity. Adipokine levels appear to correlate closely with adiposity, with increasing levels in subjects with higher body mass index (BMI) values. Many of the pro-inflammatory adipokines exert multiple actions in a variety of cellular processes leading to a complex array of abnormalities and are characteristic

Table 2. Candidate biomarkers associated with MetS

Association	Candidates biomarkers
Genes causing monogenic obesity	Leptin Leptin receptor Melanocortin receptor
Genes regulating FFA metabolism	Adiponectin Fatty acid binding protein-2 Lipases Uncoupling proteins
Genes affecting insulin sensitivity	Resistin Peroxisome proliferators Insulin receptor substrates Skeletal muscle glycogen synthase 1
Genes affecting lipid metabolism	CD36 Apolipoprotein E Upstream transcription factor 1
Genes related to inflammation	IL-6 TNF-α C-reactive protein

MetS, metabolic syndrome; FFA, free fatty acid; CD36, cluster of differentiation; IL-6, interleukin-6; TNF-α, tumor necrosis factor-α.

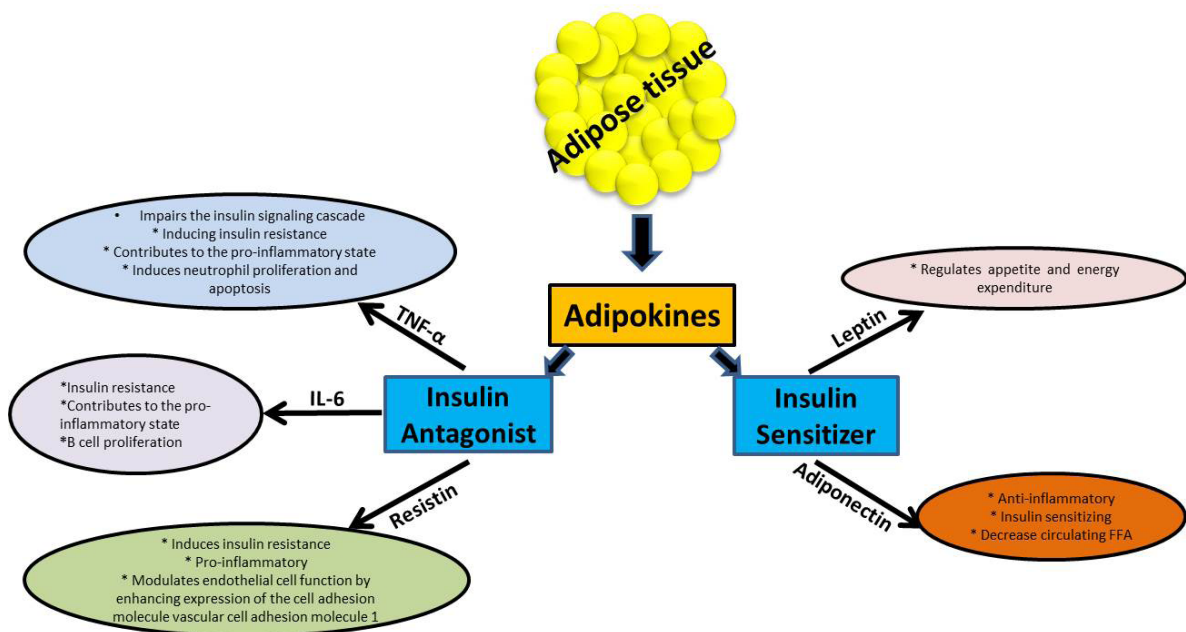

Figure 1. Bioactive proteins secreted by adipose tissue that causes IR. IL-6, interleukin-6; TNF-α, tumor necrosis factor-α. IR, insulin resistance.

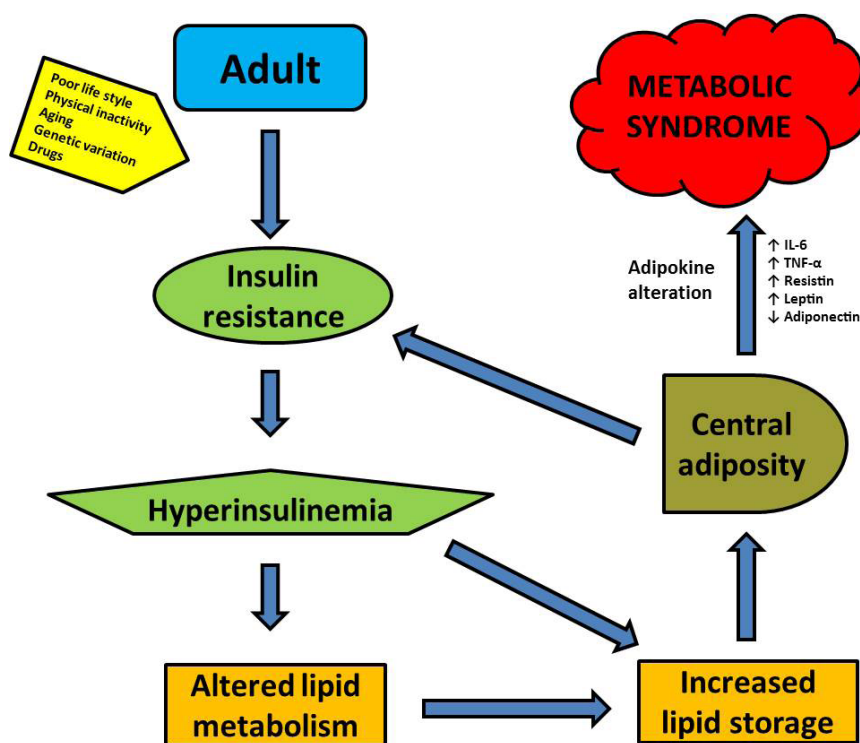

Figure 2. Pathophysiological mechanism of MetS. IL-6, interleukin-6; TNF- α , tumor necrosis factor- α . MetS, metabolic syndrome.

of MetS whereas anti-inflammatory adipokines work differently. The principal effects and the association of AT derived adipokines with IR, obesity and MetS are discussed in this article.

Adipokines and their genetic interactions with IR, obesity and MetS

Leptin

Leptin, 16kDa protein, is an adipokine secreted by AT in proportion to its mass, regulate energy homeostasis, facilitate glucose utilization, and improve insulin sensitivity. Leptin, discovered in 1994, exerts its effects through binding to the leptin receptor (Ob-R), a member of the cytokine family of trans-membrane receptors. Ob/Rb receptor has been identified as the best out of six forms of leptin receptor. The leptin receptor is in the hypothalamus increases energy expenditure and reduce appetite. The receptor is also found in kidney, liver, pancreas, smooth muscle and endometrium of heart. Patients with a complete deficiency in leptin, as a result of a mutation in the leptin gene, have been found to possess beneficial effects on energy intake, fat mass, hyperinsulinemia, and hyperlipidemia (8). However, in humans, leptin levels correlate with body fat, MetS or adiposity, suggesting that most obese individuals become insensitive to endogenous leptin and exogenous leptin administration is unlikely to have a major effect (9).

A study in normal adolescents with variable BMI

found increased leptin concentration to be associated with impaired vascular function, independent of the metabolic and inflammatory disturbances associated with obesity (10). Leptin makes an action on adipocyte cells in a paracrine fashion. Leptin expression and secretion by adipocyte cells can be induced by IL-6 and inhibited by TNF- α . In turn, leptin, suppresses the expression of resistin and increases adiponectin expression in leptin deficient ob/ob mice (11,12). It is expected that, in the absence of AT, leptin levels are very low in generalized lipodystrophy, and nonetheless the subjects are often insulin resistant.

The concept of leptin resistance or an alternate concept, "hypothalamic leptin insufficiency", has been challenged and is still unclear (12). The development of leptin resistance may involve several mechanisms including mutation in the gene, permeability of blood brain barrier, and self-regulation. One of the possible mechanisms may be the induction of leptin on suppressor of cytokine signaling-3, which interrupts the intracellular pathway of leptin (13). Second, it may be the diminished transport of leptin across the blood-brain barrier (BBB), which inhibits leptin signaling (14). Leptin signaling preserved the β -cells from the adverse effects of excessive nutrition when the fat increases and lipid accumulates in the body. Thus, improving β -cells function (15). Although, leptin receptor-mediated JAK-STAT and leptin-stimulated PI3-kinase signaling, appears to be essential in glucose metabolism for the regulation of food intake and body weight regulation, respectively

(16). Leptin hinders de novo lipogenesis (DNL) and stimulates the oxidation of FFA in liver cells. This induces lipotoxicosis and lipoapoptosis due to reduction of hepatic liver content (17). Leptin also reduces hepatic glucose release by inhibiting glycogenolysis although its molecular mechanism effecting gluconeogenesis still remains to be elucidated. Suppression of hepatic gluconeogenesis helps in creating an insulin-sensitizing milieu and reduces glucotoxicity (18).

The obese (ob) gene of leptin (LEP) is an adipocyte specific gene, which plays a central role in energy metabolism and co-modulation of body weight. The discovery of a mutation in the leptin ob-gene results in the complete absence of leptin in the ob/ob mouse. The human homologue of the leptin gene is located on chromosome 7q31.3. There are several other studies indicating the involvement of leptin gene and its receptor variations with MetS, IR, and obesity (19-21). Common SNP in the promoter region (G-2548A) of the LEP gene has been associated with variations in plasma leptin and body mass index (BMI) in obese individuals (22,23). Leptin 2548 G/A and Gln223Arg leptin receptor gene polymorphism were studied broadly because 2548 G/A gene associated with the secretion and production of leptin while Gln223Arg associated with impaired signaling capacity of the leptin receptor (24,25). A functional study explains that Leptin G-2548A polymorphism influenced leptin mRNA expression at the transcriptional level and therefore also adipose secretion levels of the hormone (24). However, supporting evidence for an association of G2548A and Gln223Arg polymorphism with leptin concentrations and MetS conflict with other studies (26,27). A separate discovery showed Leptin C/A polymorphism, at locus 2549 in the promoter region and is related to serum leptin level in western populations (22). A study of Le Stunff and his researchers has shown that girls of comparable adiposity have different circulating leptin levels, depending on their genotype at the promoter region of the leptin gene (23). Girls with Leptin 2549 C/A genotype have 25% lower mean leptin levels than girls with other genotypes. The study of the association between IR by Homeostatic Model Assessment (HOMA) and leptin genotype indicated that people carrying C-allele have more severe IR (23). Leptin gene at position 2549 carrying AA genotype was also strongly associated with cardio MetS (28).

In summary, leptin serves as a major "adipostat" by repressing food intake and promoting energy expenditure, suggesting that leptin acts as a signal that contributes to regulation of total-body sensitivity to insulin.

Adiponectin

Adiponectin is the most abundant AT derived adipocytokine comprised of a 247-amino acid protein with an increasingly important role in energy

homeostasis and insulin sensitivity. It was first isolated during adipocyte differentiation of 3T3-L1 preadipocytes following large-scale sequencing of the human adipose cDNA library. In AT, human adiponectin was cloned after mouse cloning. However, human adiponectin shared over 80% similarity with the mouse amino acids (AA). It is the only adipokine that is known to be downregulated in obesity. In addition to the association with whole-body fat mass, adiponectin levels differ with the distribution of body fat. Adiponectin is present at high concentrations in the circulation of mice and healthy humans. A study on obese mice lacking adiponectin show reduced responsiveness to peroxisome proliferator-activated receptor-gamma (PPAR γ) agonists and decreased hepatic insulin sensitivity (29).

In human studies, plasma adiponectin levels are negatively correlated with adiposity, waist-to-hip ratio (WHR) and IR, dyslipidemia and MetS, whereas levels are positively correlated with markers of insulin sensitivity (30-32). Evidence suggested that adiponectin is an important contributor to IR and MetS but the actual physiological role of adiponectin is still unclear. Due to insulin-sensitizing effect of adiponectin, it may alter glucose metabolism by fat tissue through increasing pancreatic insulin stimulated glucose uptake (33). Adiponectin gene expression in human visceral AT is negatively regulated by TNF- α and positively by insulin (34). Visceral fat was reported to be inversely associated with plasma adiponectin levels in healthy women (35). In case-control studies, low plasma adiponectin was an independent risk factor for development of T2D but not for obesity (36,37). Variations in serum adiponectin concentration have been proposed to have a strong heritable component in both predominantly Pima Indian and Northern European populations (36,38). Another study showed the changes in serum adiponectin level in postmenopausal women with MetS (39). Alternatively, adiponectin secretion may be regulated by insulin and therefore, circulating levels may be a marker of IR and a causal factor as well (40). Evidence suggests that there is a close association between IR and low adiponectin level (41).

Reproducible results of human genetic studies of diverse ethnic origin may provide evidence for its causative role in pathogenesis of the MetS and further insight into the genetic constitutions of MetS. Adiponectin is encoded by ADIPOQ (also known as APM1), located on chromosome 3q27, spans 17kb and contains 3 exons and 2 introns. Human adiponectin gene polymorphism is commonly found at the promoter region, exon and intron 2, and nonsynonymous mutations, which are rare at exon 3 region were repeatedly shown in different ethnic populations associated with the phenotypes related to body weight, glucose metabolism, insulin sensitivity, T2D and MetS (42,43).

Notably, additional support for the important role of adiponectin in IR comes from genetic studies

that have mapped a susceptibility locus for T2D and MetS in which the gene is located (44). Adiponectin gene transcription and secretion were decreased by pro-inflammatory markers, TNF- α and IL-6 (45). Adiponectin SNPs have been associated variably with increased BMI, IR-related traits and T2D (43). The adiponectin gene has been found to be consistently and significantly associated with plasma adiponectin in genetic association studies (46). The two most common reported variants of the adiponectin gene in different populations, a silent T/G substitution at position 45 in exon 2 and a G/T substitution at position 276 in intron 2, were closely associated with type II diabetes in Chinese and Japanese, visceral obesity in Swedish and Taiwanese populations and several components of MetS in Chinese and Caucasians, and IR syndrome in North Indian populations (47-53). However, the findings are still conflicting. Furthermore, +45T/G polymorphism was associated with circulating adiponectin level that added a much greater contribution to MetS. Adiponectin levels might also influence cardiac stroke, which is considered a cardiovascular event of MetS (54,55). An association between the +276G/T genotype and adiponectin levels has been observed in obese Japanese, and Spanish populations (48,56). However, in a systematic meta-analysis of all published data on adiponectin SNPs, only the +276G/T variant was a strong determinant of IR with minor allele homozygotes having a lower IR index (based on HOMA) than carriers of other genotypes. These human genetic studies on adiponectin and MetS strongly suggest that adiponectin is one of the causative factors in its pathogenesis and provide significant insights into the genetic makeup of MetS.

In summary, adiponectin is an adipocyte-derived protein with insulin sensitizing, anti-inflammatory, anti-hyperglycemic, vascular protective and anti-atherogenic properties. Although its physiological and pathophysiological roles have not been fully elucidated. High levels of adiponectin may be an important factor, which activates AMPK and stimulates phosphorylation of acetyl coenzyme A carboxylase (ACC), fatty-acid oxidation, glucose uptake and lactate production in myocytes and reduction of glucose levels *in vivo*. Adiponectin may provide a novel and potential treatment modality for IR, obesity and MetS through therapeutic modulation.

Resistin

Resistin, a 12.5kDa cysteine rich peptide, is derived from AT that has been implicated in the development of IR. Holcom *et al.* first proposed the gene family and its tissue-specific distribution, identifying a protein found in inflammatory zone called FIZZ1 *i.e.* also known as resistin-like molecules (RELM) (57). Resistin was first identified in a search for genes that were *i)* induced with adipocyte differentiation but *ii)* down-regulated

following exposure to Thiazolidinediones (TZDs). This led to the discovery of a protein named "resistin", known to be resistant to insulin (58).

Circulating resistin levels were found to be elevated in both genetic and diet-induced obesity and IR models. Therefore, it also serves as an important link between obesity and IR. A study on mice suggested that resistin selectively impairs the inhibitory action of insulin on hepatic glucose production (59). Neutralization of resistin by specific antibodies resulted in decreased blood glucose levels and improved insulin sensitivity, thereby providing a more direct link between fat mass and IR (58). By contrast, upregulated circulating resistin levels might contribute to hyperglycemia, IR, T2D, MetS and cardiovascular disease (60-63).

Human resistin is a dimeric protein containing 108 amino acids, produced and secreted mainly by peripheral-blood mononuclear cells. Human resistin is only 59% similar to the mouse protein, and this may indicate important differences in the endocrine functions of adipocytes and resistin between rodents and humans. It is also expressed and secreted by mature adipocytes. The secreted protein was found to inhibit 3T3-L1 adipogenesis, and it was speculated that resistin was a feedback regulator of adipogenesis. McTernan and coworkers reported a higher mRNA resistin expression in the abdomen than thigh region (64). Thus, this study suggested that human resistin could play a significant role in obesity-related IR. Furthermore, at least in part, elevated insulin and TNF- α levels in obesity inhibits resistin expression, which may explain the lower level of resistin found in obese diabetes. However, the role of resistin in obesity-associated IR has become controversial because additional evidence suggested that obesity and IR are associated with decreased resistin expression in AT (65).

The resistin gene is located on chromosome 19p13 a short distance from the insulin receptor. It is a small gene that spans less than 2kb and includes four exons and three introns. Screening of the entire resistin gene has eight SNPs variants and a (GAT) n microsatellite identified (66). Four SNPs were placed in the 5'-flanking region; two in intron 2, and two in intron 3 in the mouse and two in humans, encode resistin (67). These genes are present on chromosome 8 in the mouse and chromosome 19 in humans. Controversial results have been found for SNP studies on genetic variations in the resistin gene. Some case control studies demonstrated genetic variations in the resistin gene to be associated with IR and obesity in humans (68). Six SNPs were relatively frequent, with allele frequencies ranging from 0.09 to 0.43. All SNPs were in significant linkage disequilibrium, with only five haplotypes accounting for more than 80% of control chromosomes. Several polymorphisms in the resistin gene have been studied: only few have minor allele frequencies while over 5% are associated with disease risk and a few located in the 5'-flanking

region (G-638A, A-537C, C-420G and G-358A) affect circulating levels of resistin (69,70). Studies had reported much more attention to resistin SNP -420C/G, located in the promoter region of the resistin gene, and is the major determinant of plasma resistin concentration and influences resistin expression in humans (70). Several research groups identified that the circulating resistin level and specific SNPs are associated with adiposity, MetS, IR and T2D (71-73). However, other studies failed to identify changes in resistin levels or SNPs in similar conditions (74,75). In addition to SNP 420C/G, it has been reported that other polymorphisms (+299 G/A, rs3219175, rs1423096, rs3745368, and rs1477341) of the resistin gene were strongly associated with circulating resistin levels (69,76). Moreover, it has been reported that -638G/A (rs34861192) and -358G/A (rs3219175) had the strongest association with circulating resistin levels among the SNPs at the resistin locus (69,76).

In summary, resistin may represent a link between inflammation and metabolic signals and circulating resistin was more significantly correlated with central obesity and IR.

TNF- α

TNF- α is a pro-inflammatory cytokine that has been implicated in the pathogenesis of IR. TNF- α is expressed as a 26kDa cell surface trans-membrane protein that undergoes cleavage to produce a 17kDa soluble, biologically active form of TNF- α (77). Increased TNF- α production has been observed in AT derived from animal models of obesity and IR as well as in human subjects (78).

In AT, TNF- α is not secreted in the systemic circulation but acts in an autocrine and paracrine fashion. TNF- α is over expressed in AT of obese individuals. TNF- α is expressed more in visceral than in subcutaneous fat tissue, and more abundantly produced by macrophages than adipocytes (79). In humans, expression of TNF- α correlates with BMI, percent body fat and hyperinsulinaemia and weight loss decreased TNF- α levels (80). TNF- α significantly increases the expression of IL-6, reduces the expression of resistin and stimulates the secretion of leptin in 3T3-L1 adipocytes (81-83). Potential mechanisms by which AT secreted TNF- α increases IR include increased release of FFA by adipocytes and reduction in adiponectin synthesis; the cytokine directly affects insulin sensitivity by inhibiting insulin receptor signaling (45,84).

The TNF- α gene is located in the chromosomal region 6p21.1-21.3, next to the major histocompatibility complex (MHC). A SNP at position -308 upstream from the transcription initiation site in the promoter region demonstrated that polymorphism increases transcriptional activation of the TNF- α gene. TNF- α gene transcription is regulated by the promoter region, which consists of an 1,100 base pair stretch of DNA

(85). A biallelic polymorphism involves the substitution of guanine by adenine at position -308 in the promoter region, produces the less common homozygote TNF- α allele, which has been associated with elevated serum concentrations of TNF- α in certain clinical states (86,87).

Although controversial, the majority of the data support a direct role for this biallelic polymorphism in the elevation of TNF- α level observed in homozygotes for the -308 A allele (88). Some studies have indicated a key role of the TNF- α gene for the -308 variant in the pathogenesis of various components of MetS and IR (89,90). However, many other studies have reported negative results, with no correlation between TNF- α SNP and IR or any other MetS abnormality (91,92). A study of Fernandez-Real *et al.* showed that the polymorphism influenced insulin sensitivity *via* an increase in body fat in a group of non-diabetic normotensive Spanish subjects (93). While another study by Hamann *et al.* showed no difference between T2D patients and healthy control subjects in the frequency of alleles at -308 (94). Walston and coworkers reported that TNF- α polymorphism at -308 polymorphic sites did not relate to any traits of obesity and IR in a group of non-diabetic subjects (95).

In summary, TNF- α seems to play an important role in the development of IR in rodents, but the *in vivo* data in humans has not been as conclusive. Additional human studies are needed to understand its role in the pathogenesis of IR in humans.

IL-6

IL-6 is a pleiotropic circulating cytokine with effects ranging from inflammation to host defense to tissue injury and it is one of several pro-inflammatory cytokines that have been associated with MetS as a biological marker. IL-6 is secreted by immune cells, fibroblasts, endothelial cells, skeletal muscle and AT. It circulates as a variably glycosylated 26kDa protein. IL-6 concentrations increase with adiposity, and 15-35% of circulating IL-6 may be released by AT *in vivo*. In AT, IL-6 reduces lipoprotein lipase activity and increases basal lipolysis (96).

Studies suggest that IL-6 may stimulate fat lipolysis in human adipocytes thus leading to increase circulating FFA (97). Fasting plasma IL-6 concentrations were negatively correlated with the rate of insulin-stimulated glucose disposal in Pima Indians (98). Bastard and colleagues reported that increased IL-6 values were more strongly correlated with obesity and IR, significant decreases in circulating IL-6 and TNF- α levels responded to diet-induced weight loss in obese women (98,99). Other studies also had similar observations that weight loss results decrease circulating IL-6 levels (100). Overall, the association of IL-6 and IR seems complex and IL-6 alone might not be an appropriate marker of IR or MetS. IL-6 may also exert its adverse effects by decreasing adiponectin secretion.

Our study showed increased circulating IL-6 levels in obese and MetS women (101). Hyperinsulinemia positively associated with TNF- α and IL-6 gene expression while hyperinsulinemia and glucose intolerance were negatively linked to adiponectin expression in AT (102,103). IL-6 also increases the expression of resistin in human peripheral blood mononuclear cells (104). Visceral AT releases two to three times greater IL-6 compared to subcutaneous AT. Although, it seems that the majority of AT-derived IL-6 comes from stromal immune cells and not adipocytes (105). Rotter *et al.* reported a reduction in the expression of insulin receptor substrate-1 (IRS-1) and glucose transporter 4 (GLUT4) in adipocytes response to IL-6 treatment (106). Due to visceral depots drain into the portal circulation, the metabolic effects of IL-6 in the liver become important. Indeed, there is evidence that suggests IL-6 inhibits insulin receptor signal transduction in hepatocytes that is mediated by induction of SOCS-3 (107).

The association of IL-6 with MetS is supported by epidemiological and genetic studies. Genetic studies have also demonstrated a strong correlation between IR and IL-6 gene polymorphisms in Native Americans and Caucasians (108). Another study, which is in agreement with the study on Caucasian populations, suggests that IL-6 receptor (IL-6R, rs8192284-A/C, Asp358Ala) SNPs may play a role in the pathogenesis of MetS possibly through modulating IL-6 levels (109). The -174 G/C variant of IL-6 gene has been shown to influence the transcriptional regulation of IL-6 and human -174 G allele carriers exhibit higher plasma IL-6 levels compared with homozygous C-allele carriers, an effect which is modulated by age and gender both (110,111). However, the results have been incompatible in other studies and subjects of different ethnic origins have linked the -174 G/C variant of IL-6 gene to indices of obesity and IR. In Native Americans and Caucasians, the GG genotype was associated with T2D whereas Swedish and French Canadian population showed that the C-allele was associated with indices of obesity (108,112,113). In Spanish populations, the G-allele has been related to decreased insulin sensitivity, hyperglycemia and abnormalities in lipids (114,115).

Two other functional SNPs in the IL-6 promoter at positions -597 and -572 were also identified (116,117). It has also been shown that three SNPs (-174, -572, -597) of the IL-6 promoter do not act independently in the regulation of IL-6 transcription (118). Studies showed that an IL-6 SNP within a sequence, bearing partial nucleotide homology with the Sma- and Mad-related protein 4 (Smad4) binding element and the presence of the C-allele may bind Smad 4 more effectively and inhibit IL-6 transcription (119). A study of a lipopolysaccharide stimulated IL-6 production result demonstrated that leucocytes from the homozygous carrier of the GGG-haplotype (-597 GG, -572 GG and

-174 GG) produced the highest amount of IL-6 (118).

In summary, IL-6 plays a crucial role in the regulation of many adipokines, modulation of immune function and the regulation of a variety of cellular functions and IR.

Effect of adipokines on insulin signaling

Do the adipokines affect insulin sensitivity by altering the mechanism of insulin signaling? Insulin binding to insulin receptor activates IRS proteins that subsequently recruit and activate the phosphoinositide 3-kinase (PI3K) pathway. Reduced activation of PI3K by insulin is a predominant feature of IR and has been implicated in the pathogenesis of hypertension in skeletal muscle.

PI3 kinase is able to play a central role in the metabolic and mitogenic actions of insulin. PI3K has also been demonstrated to mediate some of the actions of adiponectin and leptin in various tissues, including vascular endothelium and skeletal muscle (120,121). In skeletal muscle, adiponectin stimulates glucose transport by increased GLUT4 translocation, activates insulin signaling, and upregulates molecules involved in fatty acid transport (122). Leptin has been demonstrated to impair insulin signaling in adipocytes and modulate insulin action in liver and muscle (123). Resistin, a potent inflammatory regulator, may exert an inhibitory effect on nitric oxide production by inhibiting insulin signaling and eNOS phosphorylation in endothelial cells. IL-6 attenuates IRS-1 expression and insulin-stimulated Akt activation in hepatocytes and adipocytes (106,107,124). The effects of leptin and IL-6 on insulin signaling in the endothelium remain uncharted. However, TNF- α has been shown to interfere with intracellular insulin signaling pathways in endothelial cells, and therefore represents a candidate mechanism by which it leads to impaired insulin action (125). TNF- α has been demonstrated to increase serine phosphorylation of IRS-1 in adipocytes, which reduces its capacity to recruit and activate downstream effectors of insulin (124,126).

Future prospective

MetS has reached dramatic proportions affecting adults worldwide. MetS is associated with a plethora of health problems including IR, hypertriglyceridemia, atherosclerosis and T2D. Excess amounts of visceral fat accumulation results in altered release of adipokines, leading to IR. The syndrome epidemic affects children, who are becoming overweight and obese at progressively younger ages. Most of the clinical recommendations for treatment of younger age obesity and associated disorders are based on the combination of several lifestyle interventions, such as eating habits, medication support and regular physical activities. The role of adipokines as biomarkers in physiology and pathophysiology has only been appreciated recently.

Previous studies have shown that targeting circulating

adipokine levels and their receptors expression can decrease IR, improve vascular function, and significantly lower the risk of cardiovascular morbidity and mortality. At least some of the adipokines, such as adiponectin, seems to be important in maintaining metabolic homeostasis, but others may contribute to the development of IR during the time when food is plentiful. The mechanisms by which adipokines promote IR are complex. It appears that intense AT deposition in the omental region, may be exorbitant partially through the secretion of adipokines such as resistin, TNF, and IL-6. In contrast, the presence of AT is vital in the prevention of IR, at least in part, *via* leptin and adiponectin secretion. Some of these adipokines are also recognized in the immune system and may play a role in linking the nutritional system with the immune system. Finally, determining the relative contribution of adipokines to MetS and elucidating the dynamic interactions between adipokines as biomarkers for MetS should be a focus of our research in the future.

Acknowledgements

We would like to thank everyone who participated and provide suggestions with intense discussions as well as critical review of the manuscript.

Funding: None.

Conflict of Interest: The authors have no conflicts of interest to disclose.

References

- Saklayen MG. The global epidemic of the metabolic syndrome. *Curr Hypertens Rep.* 2018; 20:1-8.
- Gupta A, Gupta V. Metabolic syndrome: what are the risks for humans? *Biosci Trends.* 2010; 4:204-212.
- Kim JE, Kim JS, Jo MJ, Cho E, Ahn SY, Kwon YJ, Ko GJ. The roles and associated mechanisms of adipokines in development of metabolic syndrome. *Molecules.* 2022; 27:334.
- Expert Panel on Detection, Evaluation, and Treatment of High Blood Cholesterol in Adults. Executive summary of the Third Report of the National Cholesterol Education Program (NCEP) Expert Panel on Detection, Evaluation, and Treatment of High Blood Cholesterol in Adults (Adult Treatment Panel III). *JAMA.* 2001; 285:2486-2497.
- Trayhurn P, Wood IS. Adipokines: inflammation and the pleiotropic role of white adipose tissue. *Br J Nutr.* 2004; 92:347-355.
- Anastassios GP, Nandini AJ, Greenberg AS. Adipocytokines and insulin resistance. *J Clin Endocrinol Metab.* 2004; 89:447-452.
- Fahed G, Aoun L, Zerdan MB, Allam S, Zerdan MB, Bouferraa Y, Assi HI. Metabolic syndrome: updates on pathophysiology and management in 2021. *Int J Mol Sci.* 2022; 23:786.
- Obradovic M, Sudar-Milovanovic E, Soskic S, Essack M, Arya S, Stewart AJ, Gojobori T, Isenovic ER. Leptin and obesity: role and clinical implication. *Front Endocrinol (Lausanne).* 2021; 12:585887.
- Martins Mdo C, Lima Faleiro L, Fonseca A. Relationship between leptin and body mass and metabolic syndrome in an adult population. *Rev Port Cardiol.* 2012; 31:711-719.
- Singhal A, Farooqi S, Cole TJ, O'Rahilly S, Fewtrell M, Kattenhorn M, Lucas A, Deanfield J. Influence of leptin on arterial distensibility: a novel link between obesity and cardiovascular disease? *Circulation.* 2002; 106:1919-1924.
- Delporte ML, El Mkaem SA, Quisquater M, Brichard SM. Leptin treatment markedly increased plasma adiponectin but barely decreased plasma resistin of ob/ob mice. *Am J Physiol Endocrinol Metab.* 2004; 287:E446-E453.
- Masuzaki H, Tanaka T, Ebihara K, Hosoda K, Nakao K. Hypothalamic melanocortin signaling and leptin resistance—perspective of therapeutic application for obesity-diabetes syndrome. *Peptides.* 2009; 30:1383-1386.
- Munzberg H, Myers MG Jr. Molecular and anatomical determinants of central leptin resistance. *Nat Neurosci.* 2005; 8:566-570.
- Kalra SP. Central leptin insufficiency syndrome: an interactive etiology for obesity, metabolic and neural diseases and for designing new therapeutic interventions. *Peptides.* 2008; 29:127-138.
- Morioka T, Asilmaz E, Hu J, Dishinger JF, Kurpad AJ, Elias CF, Li H, Elmquist JK, Kennedy RT, Kulkarni RN. Disruption of leptin receptor expression in the pancreas directly affects beta cell growth and function in mice. *J Clin Invest.* 2007; 117:2860-2868.
- Morton GJ. Hypothalamic leptin regulation of energy homeostasis and glucose metabolism. *J Physiol.* 2007; 583:437-443.
- Martínez UM, López MY, Diéguez C, Fernández-Rojo MA, Novelle MG. Unraveling the role of leptin in liver function and its relationship with liver diseases. *Int J Mol Sci.* 2020; 21:1-33.
- Moon HS, Dalamaga M, Kim SY, Polyzos SA, Hamnvik OP, Magkos F, Paruthi J, Mantzoros CS. Leptin's role in lipodystrophic and nonlipodystrophic insulin-resistant and diabetic individuals. *Endocr Rev.* 2013; 34:377-412.
- Shramko II, Ageeva ES, Maliy KD, Repinskaya IN, Tarimov CO, Fomochkina II, Kubishkin AV, Ostapenko OV, Gurtovaya AK, Shekhar S. Association between adiponectin and leptin receptor genetic polymorphisms and clinical manifestations of metabolic syndrome. *J Diabetes Res.* 2022; 2022:9881422.
- Adiga U, Banawalikar N, Mayur S, Bansal R, Ameera N, Rao S. Association of insulin resistance and leptin receptor gene polymorphism in type 2 diabetes mellitus. *J Chin Med Assoc.* 2021; 84:383-388.
- Hastuti P, Zukhrufia I, Made Padwaswari MH, Nuraini A, Sadewa AH. Polymorphism in leptin receptor gene was associated with obesity in Yogyakarta, Indonesia. *Egypt J Med Hum Genet.* 2016; 17:271-276.
- Mammes O, Betoulle D, Aubert R, Giraud V, Tuzet S, Petiet A, Colas-Linhart N, Fumeron F. Novel Polymorphisms in the 5' region of the LEP Gene: Association with Leptin Levels and Response to Low-Calorie Diet in Human Obesity. *Diabetes.* 1998; 47:487-489.
- Le Stunff C, Le Bihan C, Schork NJ, Bougneres P. A common promoter variant of the leptin gene is associated with changes in the relationship between serum leptin and

- fat mass in obese girls. *Diabetes*. 2000; 49:2196-2200.
24. Hoffstedt J, Eriksson P, Mottagui-Tabar S, Arner P. A polymorphism in the leptin promoter region (-2548 G/A) influences gene expression and adipose tissue secretion of leptin. *Horm Metab Res*. 2002; 34:355-359.
 25. Yiannakouris N, Yannakoulia M, Melistas L, Chan JL, Klimis-Zacas D, Mantzoros CS. The Q223R polymorphism of the leptin receptor gene is significantly associated with obesity and predicts a small percentage of body weight and body composition variability. *J Clin Endocrinol Metab*. 2001; 86:4434-4439.
 26. Boumaiza I, Omezzine A, Rejeb J, Rebhi L, Ouedrani A, Ben Rejeb N, Nabli N, Ben Abdelaziz A, Bouslama A. Relationship between leptin G2548A and leptin receptor Q223R gene polymorphisms and obesity and metabolic syndrome risk in Tunisian volunteers. *Genet Test Mol Biomarkers*. 2012; 16:726-733.
 27. Komşu-Ornek Z, Demirel F, Dursun A, Ermiş B, Pişkin E, Bideci A. Leptin receptor gene Gln223Arg polymorphism is not associated with obesity and metabolic syndrome in Turkish children. *Turk J Pediatr*. 2012; 54:20-24. (in Turkish)
 28. Kumar S, Srivastava N, Mishra S, Natu SM, Roy U, Chandra A, Kumar S, Gupta V. Association of leptin 2549C/A gene polymorphism with metabolic risk markers in adult women of North India. *Inter J Biol Pharma Res*. 2014; 5:921-926.
 29. Nawrocki AR, Rajala MW, Tomas E, Pajvani UB, Saha AK, Trumbauer ME, Pang Z, Chen AS, Ruderman NB, Chen H, Rossetti L, Scherer PE. Mice lacking adiponectin show decreased hepatic insulin sensitivity and reduced responsiveness to peroxisome proliferator-activated receptor gamma agonists. *J Biol Chem*. 2006; 281:2654-2660.
 30. Cnop M, Havel PJ, Utzschneider KM, Carr DB, Sinha MK, Boyko EJ, Retzlaff BM, Knopp RH, Brunzell JD, Kahn SE. Relationship of adiponectin to body fat distribution, insulin sensitivity and plasma lipoproteins: evidence for independent roles of age and sex. *Diabetologia*. 2003; 46:459-469.
 31. Karasek D, Vaverkova H, Halenka M, Jackuliakova D, Frysak Z, Novotny D. Total adiponectin levels in dyslipidemic individuals: relationship to metabolic parameters and intima-media thickness. *Biomed Pap Med Fac Univ Palacky Olomouc Czech Repub*. 2011; 155:55-62. (in Czech)
 32. Hung J, McQuillan BM, Thompson PL, Beilby JP. Circulating adiponectin levels associate with inflammatory markers, insulin resistance and metabolic syndrome independent of obesity. *Int J Obes (Lond)*. 2008; 32:772-779.
 33. Okamoto M, Ohara-Imaizumi M, Kubota N, Hashimoto S, Eto K, Kanno T, Kubota T, Wakui M, Nagai R, Noda M, Nagamatsu S, Kadowaki T. Adiponectin induces insulin secretion *in vitro* and *in vivo* at a low glucose concentration. *Diabetologia*. 2008; 51:827-835.
 34. Boullu-Ciocca S, Achard V, Tassistro V, Dutour A, Grino M. Postnatal programming of glucocorticoid metabolism in rats modulates high-fat diet-induced regulation of visceral adipose tissue glucocorticoid exposure and sensitivity and adiponectin and proinflammatory adipokines gene expression in adulthood. *Diabetes*. 2008; 57:669-677.
 35. Kwon K, Jung SH, Choi C, Park SH. Reciprocal association between visceral obesity and adiponectin: in healthy premenopausal women. *Int J Cardiol*. 2005; 101:385-390.
 36. Lindsay RS, Funahashi T, Hanson RL, Matsuzawa Y, Tanaka S, Tataranni PA, Knowler WC, Krakoff J. Adiponectin and development of type 2 diabetes in the Pima Indian population. *Lancet*. 2002; 360:57-58.
 37. Magge SN, Stettler N, Koren D, Levitt Katz LE, Gallagher PR, Mohler ER 3rd, Rader DJ. Adiponectin is associated with favorable lipoprotein profile, independent of BMI and insulin resistance, in adolescents. *J Clin Endocrinol Metab*. 2011; 96:1549-1554.
 38. Comuzzie AG, Funahashi T, Sonnenberg G, Martin LJ, Jacob HJ, Black AE, Maas D, Takahashi M, Kihara S, Tanaka S, Matsuzawa Y, Blangero J, Cohen D, Kissebah A. The genetic basis of plasma variation in adiponectin, a global endophenotype for obesity and the metabolic syndrome. *J Clin Endocrinol Metab*. 2001; 86:4321-4325.
 39. Srivastava N, Gupta V, Kumar S. Association between circulating adiponectin level and metabolic risk factors in postmenopausal women: a population based study. *Inter J Biol Pharma Res*. 2015; 6:939-943.
 40. Ruan H, Dong LQ. Adiponectin signaling and function in insulin target tissues. *J Mol Cell Biol*. 2016; 8:101-109.
 41. Hivert MF, Sullivan LM, Fox CS, Nathan DM, D'Agostino RB Sr., Wilson PW, Meigs JB. Associations of adiponectin, resistin, and tumor necrosis factor-alpha with insulin resistance. *J Clin Endocrinol Metab*. 2008; 93:3165-3172.
 42. Filippi E, Sentinelli F, Trischitta V, Romeo S, Arca M, Leonetti F, Di Mario U, Baroni MG. Association of the human adiponectin gene and insulin resistance. *Eur J Hum Genet*. 2004; 12:199-205.
 43. Menzaghi C, Trischitta V, Doria A. Genetic influences of adiponectin on insulin resistance, type 2 diabetes, and cardiovascular disease. *Diabetes*. 2007; 56:1198-1209.
 44. Vionnet N, Hani El H, Dupont S, Gallina S, Francke S, Dotte S, De Matos F, Durand E, Leprêtre F, Lecoœur C, Gallina P, Zekiri L, Dina C, Froguel P. Genome wide search for type 2 diabetes-susceptibility genes in French whites: evidence for a novel susceptibility locus for early-onset diabetes on chromosome 3q27-qter and independent replication of a type 2-diabetes locus on chromosome 1q21-q24. *Am J Hum Genet*. 2002; 67:1470-1480.
 45. Bruun JM, Lihn AS, Verdich C, Pedersen SB, Toubro S, Astrup A, Richelsen B. Regulation of adiponectin by adipose tissue-derived cytokines: *in vivo* and *in vitro* investigations in humans. *Am J Physiol Endocrinol Metab*. 2003; 285:E527-E533.
 46. Ling H, Waterworth DM, Stirnadel HA, Pollin TI, Barter PJ, Kesaniemi YA, Mahley RW, McPherson R, Waeber G, Bersot TP, Cohen JC, Grundy SM, Mooser VE, Mitchell BD. Genome-wide linkage and association analyses to identify genes influencing adiponectin levels: the GEMS study. *Obesity (Silver Spring)*. 2009; 17:737-744.
 47. Wang WL, Zhu H, Xie Y, Li J. Relation between ADIPOQ gene polymorphisms and type 2 diabetes in a Chinese population. *Int J Clin Exp Med*. 2015; 15:6124-6128.
 48. Hara K, Boutin P, Mori Y, *et al*. Genetic variation in the gene encoding adiponectin is associated with an increased risk of type 2 diabetes in the Japanese population. *Diabetes*. 2002; 51:536-540.
 49. Ukkola O, Ravussin E, Jacobson P, Sjostrom L, Bouchard C. Mutations in the adiponectin gene in lean and obese subjects from the Swedish obese subject cohort. *Metabolism*. 2003; 52:881-884.

50. Yang WS, Yang YC, Chen CL, Wu IL, Lu JY, Lu FH, Tai TY, Chang CJ. Adiponectin SNP276 is associated with obesity, the metabolic syndrome, and diabetes in the elderly. *Am J Clin Nutr.* 2007; 86:509-513.
51. Gao M, Ding D, Huang J, Huang J, Qu Y, Wang Y, Huang Q. Association of genetic variants in the adiponectin gene with metabolic syndrome: a case-control study and a systematic meta-analysis in the Chinese population. *PLoS One.* 2013; 8:e58412.
52. Menzaghi C, Ercolino T, Di Paola R, Berg AH, Warram JH, Scherer PE, Trischitta V, Doria A. A haplotype at the adiponectin locus is associated with obesity and other features of the insulin resistance syndrome. *Diabetes.* 2002; 51:2306-2312.
53. Prakash J, Mittal B, Awasthi S, Srivastava N. Association of adiponectin gene polymorphism with adiponectin levels and risk for insulin resistance syndrome. *Int J Prev Med.* 2015; 6:31.
54. Wu J, Liu Z, Meng K, Zhang L. Association of adiponectin gene (ADIPOQ) rs2241766 polymorphism with obesity in adults: a meta-analysis. *PLoS One.* 2014; 9:e95270.
55. Hao G, Li W, Guo R, Yang JG, Wang Y, Tian Y, Liu MY, Peng YG, Wang ZW. Serum total adiponectin level and the risk of cardiovascular disease in general population: a meta-analysis of 17 prospective studies. *Atherosclerosis.* 2013; 228:29-35.
56. de Luis DA, Izaola O, de la Fuente B, Primo D, Fernandez Ovalle H, Romero E. rs1501299 Polymorphism in the adiponectin gene and their association with total adiponectin levels, Insulin resistance and metabolic syndrome in obese subjects. *Ann Nutr Metab.* 2016; 69:226-231.
57. Holcomb IN, Kabakoff RC, Chan B, Baker TW, Gurney A, Henzel W, Nelson C, Lowman HB, Wright BD, Skelton NJ, Frantz GD, Tumas DB, Peale FV Jr, Shelton DL, Hébert CC. FIZZ1, a novel cysteine-rich secreted protein associated with pulmonary inflammation, defines a new gene family. *EMBO J.* 2000; 19:4046-4055.
58. Steppan CM, Bailey ST, Bhat S, Brown EJ, Banerjee RR, Wright CM, Patel HR, Ahima RS, Lazar MA. The hormone resistin links obesity to diabetes. *Nature.* 2001; 409:307-312.
59. Rajala MW, Obici S, Scherer PE, Rossetti L. Adipose-derived resistin and gut-derived resistin-like molecule selectively impair insulin action on glucose production. *J Clin Invest.* 2003; 111:225-230.
60. Chen BH, Song, Y, Ding EL, Roberts CK, Manson JE, Rifai N, Buring JE, Gaziano JM, Liu S. Circulating levels of resistin and risk of type 2 diabetes in men and women: results from two prospective cohorts. *Diabetes Care.* 2009; 32:329-334.
61. Gupta V, Singh AK, Gupta A, Gupta V, Kumar S, Srivastava N, Jafar T, Pant AB. Association of circulating resistin with metabolic risk factors in Indian females having metabolic syndrome. *Toxicol Int.* 2011; 18:168-172.
62. Singh AK, Tiwari S, Gupta A, Natu SM, Mittal B, Pant AB. Association of resistin with metabolic syndrome in Indian Subjects. *Metab Syndr Relat Disord.* 2012; 10:286-291.
63. Singh AK, Tiwari S, Gupta A, Shukla KK, Chhabra KG, Pandey A, Pant AB. Association of resistin with Insulin resistance and factors of metabolic syndrome in North Indians. *Indian J Clin Biochem.* 2015; 30:255-262.
64. McTernan CL, McTernan PG, Harte AL, Levick PL, Barnett AH, Kumar S. Resistin, central obesity, and type 2 diabetes. *Lancet.* 2002; 359:46-47.
65. Way JM, Gorgun CZ, Tong Q, Uysal KT, Brown KK, Harrington WW, Oliver WR Jr, Willson TM, Kliever SA, Hotamisligil GS. Adipose tissue resistin expression is severely suppressed in obesity and stimulated by peroxisome proliferator-activated receptor gamma agonists. *J Biol Chem.* 2001; 276:25651-25653.
66. Ma X, Warram JH, Trischitta V, Doria A. Genetic variants at the resistin locus and risk of type 2 diabetes in Caucasians. *J Clin Endocrinol Metab.* 2002; 87:4407-4410.
67. Ghosh S, Singh AK, Aruna B, Mukhopadhyay S, Ehtesham NZ. The genomic organization of mouse resistin reveals major differences from the human resistin: functional implications. *Gene.* 2003; 305:27-34.
68. Wang H, Chu WS, Hemphill C, Elbein SC. Human resistin gene: molecular scanning and evaluation of association with insulin sensitivity and type 2 diabetes in Caucasians. *J Clin Endocrinol Metab.* 2002; 87:2520-2524.
69. Asano H, Izawa H, Nagata K, Nakatochi M, Kobayashi M, Hirashiki A, Shintani S, Nishizawa T, Tanimura D, Naruse K, Matsubara T, Murohara T, Yokota M. Plasma resistin concentration determined by common variants in the resistin gene and associated with metabolic traits in an aged Japanese population. *Diabetologia.* 2010; 53:234-246.
70. Cho YM, Youn BS, Chung SS, Kim KW, Lee HK, Yu KY, Park HJ, Shin HD, Park KS. Common genetic polymorphisms in the promoter of resistin gene are major determinants of plasma resistin concentrations in humans. *Diabetologia.* 2004; 47:559-565.
71. Boumaiza I, Omezzine A, Rejeb J, Rebhi L, Rejeb NB, Nabli N, Abdelaziz AB, Bouslama A. Association between four resistin polymorphisms, obesity, and metabolic syndrome parameters in Tunisian volunteers. *Genet Test Mol Biomarkers.* 2012; 16:1356-1362.
72. Osawa H, Tabara Y, Kawamoto R, Ohashi J, Ochi M, Onuma H, Nishida W, Yamada K, Nakura J, Kohara K, Miki T, Makino H. Plasma resistin associated with single nucleotide polymorphism -420, is correlated with insulin resistance, lower HDL cholesterol, and high sensitivity C-reactive protein in the Japanese general population. *Diabetes Care.* 2007; 30:1501-1506.
73. Rathwa N, Patel R, Palit SP, Ramachandran AV, Begum R. Genetic variants of resistin and its plasma levels: association with obesity and dyslipidemia related to type 2 diabetes susceptibility. *Genomics.* 2019; 111: 980-985.
74. Pagano C, Soardo G, Pilon C, Milocco C, Basan L, Milan G, Donnini D, Faggian D, Mussap M, Plebani M, Avellini C, Federspil G, Sechi LA, Vettor R. Increased serum resistin in nonalcoholic fatty liver disease is related to liver disease severity and not to insulin resistance. *J Clin Endocrinol Metab.* 2006; 91:1081-1086.
75. Beckers S, Peeters AV, Freitas F, Mertens IL, Hendrickx JJ, Van Gaal LF, Van Hul W. Analysis of genetic variations in the resistin gene shows no associations with obesity in women. *Obesity (Silver Spring).* 2008; 16:905-907.
76. Onuma H, Tabara Y, Kawamura R, Tanaka T, Ohashi J, Nishida W, Takata Y, Ochi M, Yamada K, Kawamoto R, Kohara K, Miki T, Makino H, Osawa H. A at single nucleotide polymorphism-358 is required for G at -420 to confer the highest plasma resistin in the general Japanese population. *PLoS One.* 2010; 5:e9718.

77. Ji ZZ, Dai Z, Xu YC. A new tumor necrosis factor (TNF)- α regulator, lipopolysaccharides-induced TNF- α factor, is associated with obesity and insulin resistance. *Chin Med J (Engl)*. 2011; 124:177-182.
78. Hotamisligil GS, Arner P, Caro JF, Atkinson RL, Spiegelman BM. Increased adipose tissue expression of tumor necrosis factor alpha in human obesity and insulin resistance. *J Clin Invest*. 1995; 95:2409-2415.
79. Maury E, Noel L, Detry R, Brichard SM. *In vitro* hyper-responsiveness to TNF- α contributes to adipokine dysregulation in omental adipocytes of obese subjects. *J Clin Endocrinol Metab*. 2009; 94:1393-1400.
80. Jellema A, Plat J, Mensink RP. Weight reduction, but not a moderate intake of fish oil, lowers concentrations of inflammatory markers and PAI-1 antigen in obese men during the fasting and postprandial state. *Eur J Clin Invest*. 2004; 34:766-773.
81. Fasshauer M, Klein J, Lossner U, Paschke R. Interleukin-6 mRNA expression is stimulated by insulin, isoproterenol, tumour necrosis factor alpha, growth hormone, and IL-6 in 3T3-L1 adipocytes. *Horm Metab Res*. 2003; 35:147-152.
82. Fasshauer M, Klein J, Neumann S, Eszlinger M, Paschke R. Tumor necrosis factor alpha is a negative regulator of resistin gene expression and secretion in 3T3-L1 adipocytes. *Biochem Biophys Res Commun*. 2001; 288:1027-1031.
83. Trujillo ME, Lee MJ, Sullivan S, Feng J, Schneider SH, Greenberg AS, Fried SK. Tumor necrosis factor alpha and glucocorticoid synergistically increase leptin production in human adipose tissue: role for p38 mitogen-activated protein kinase. *J Clin Endocrinol Metab*. 2006; 91:1484-1490.
84. Greenberg AS, McDaniel ML. Identifying the links between obesity, cytokines in the pathogenesis of type 2 diabetes. *Eur J Clin Invest*. 2002; 32:24-34.
85. Wilson AG, de Vries N, Pociot F, di Giovine FS, van der Putte LB, Duff GW. An allelic polymorphism within the human tumor necrosis factor promoter region is strongly associated with HLA A1, B8 and DR3 alleles. *J Exp Med*. 1993; 177:557-560.
86. Wilson AG, Symons JA, McDowell TL, McDevitt HO, Duff GW. Effects of a polymorphism in the human tumor necrosis factor promoter on transcriptional activation. *Proc Natl Acad Sci USA*. 1997; 94:3195-3199.
87. Gupta V, Gupta A, Jafar T, Gupta V, Agrawal S, Srivastava N, Kumar S, Singh AK, Natu SM, Agarwal CG, Agarwal GG. Association of TNF- α promoter gene G-308A polymorphism with metabolic syndrome, insulin resistance, serum TNF- α and leptin levels in Indian adult women. *Cytokine*. 2012; 57:32-36.
88. Abraham LJ, Kroeger KM. Impact of the -308 TNF promoter polymorphism on the transcriptional regulation of the TNF gene: relevance to disease. *J Leukoc Biol*. 1999; 66:562.
89. Joffe YT, Merwe LVD, Carstens M, Collins M, Jennings C, Levitt NS, Lambert EV, Goedecke JH. Tumor Necrosis Factor- α Gene -308 G/A Polymorphism Modulates the Relationship between Dietary Fat Intake, Serum Lipids, and Obesity Risk in Black South African Women. *J Nutr*. 2010; 140:901-907.
90. Sookoian SC, González C, Pirola CJ. Meta-analysis on the G-308A tumor necrosis factor alpha gene variant and phenotypes associated with the metabolic syndrome. *Obes Res*. 2005; 13:2122-2131.
91. Mirhafez SR, Avan A, Pasdar A, Kazemi E, Ghasemi F, Tajbakhsh A, Tabaei S, Ferns GA, Ghayour-Mobarhan M. Association of tumor necrosis factor- α promoter G-308A gene polymorphism with increased triglyceride level of subjects with metabolic syndrome. *Gene*. 2015; 568:81-84.
92. Pyrzak B, Wisniewska A, Rymkiewicz-Kluczynska B. Tumor necrosis factor alpha (TNF- α) gene G-308A polymorphism relationship to insulin resistance and lipid abnormalities in children with obesity. *Endokrynol Diabetol Chor Przemiany Materii Wieku Rozw*. 2006; 12:171-174. (in Polish)
93. Fernandez-Real JM, Gutierrez C, Ricart W, Casamitjana R, Fernandez-Castaner M, Vendrell J, Richart C, Soler J. The TNF- α gene NCO I polymorphism influences the relationship among insulin resistance, percent body fat, and increased serum leptin levels. *Diabetes*. 1997; 46:1468-1472.
94. Hamann A, Mantzoros C, Vidal-Puig A, Flier JS. Genetic variability in the TNF- α promoter is not associated with type II diabetes mellitus (NIDDM). *Biochem Biophys Res Commun*. 1995; 211:833-839.
95. Walston J, Seibert M, Yen CJ, Cheskin LJ, Andersen RE. Tumor necrosis factor-alpha-238 and-308 polymorphisms do not associate with traits related to obesity and insulin resistance. *Diabetes*. 1999; 48:2096-2098.
96. Mattacks CA, Pond CM. Interactions of noradrenalin and tumor necrosis factor, interleukin-4 and interleukin-6 in the control of lipolysis from adipocytes around lymph nodes. *Cytokine*. 1999; 11:334-346.
97. Path G, Bornstein SR, Gurniak M, Chrousos GP, Scherbaum WA, Hauner H. Human breast adipocytes express interleukin-6 (IL-6) and its receptor system: increased IL-6 production by beta-adrenergic activation and effects of IL-6 on adipocyte function. *J Clin Endocrinol Metab*. 2001; 86:2281-2288.
98. Vozarova B, Weyer C, Hanson K, Tataranni PA, Bogardus C, Pratley RE. Circulating interleukin-6 in relation to adiposity, insulin action, and insulin secretion. *Obes Res*. 2001; 9:414-417.
99. Bastard JP, Jardel C, Bruckert E, Blondy P, Capeau J, Laville M, Vidal H, Hainque B. Elevated levels of interleukin 6 are reduced in serum and subcutaneous adipose tissue of obese women after weight loss. *J Clin Endocrinol Metab*. 2000; 85:3338-3342.
100. Kopp HP, Kopp CW, Festa A, Krzyzanowska K, Kriwanek S, Minar E, Roka R, Scherthaner G. Impact of weight loss on inflammatory proteins and their association with the insulin resistance syndrome in morbidly obese patients. *Arterioscler Thromb Vasc Biol*. 2003; 23:1042-1047.
101. Gupta A, Gupta V, Singh AK, Tiwari S, Agrawal S, Natu SM, Agrawal CG, Negi MP, Pant AB. Interleukin-6 G-174C gene polymorphism and serum resistin levels in North Indian women: potential risk of metabolic syndrome. *Hum Exp Toxicol*. 2011; 30:1445-1453.
102. Krogh-Madsen R, Plomgaard P, Keller P, Keller C, Pedersen BK. Insulin stimulates interleukin-6 and tumor necrosis factor- α gene expression in human subcutaneous adipose tissue. *Am J Physiol Endocrinol Metab*. 2004; 286:E234-E238.
103. Fasshauer M, Klein J, Neumann S, Eszlinger M, Paschke R. Hormonal regulation of adiponectin gene expression in 3T3-L1 adipocytes. *Biochem Biophys Res Commun*. 2002; 290:1084-1089.

104. Kaser S, Kaser A, Sandhofer A, Ebenbichler CF, Tilg H, Patsch JR. Resistin-mRNA expression increased by proinflammatory cytokines *in vitro*. *Biochem Biophys Res Commun*. 2003; 309:286-290.
105. Gomez-Huelgas R, Ruiz-Nava J, Santamaria-Fernandez S, Vargas-Candela A, Alarcon-Martin AV, Tinahones FJ, Bernal-Lopez MR. Impact of intensive lifestyle modification on levels of adipokines and inflammatory biomarkers in metabolically healthy obese women. *Mediators Inflamm*. 2019; 2019:4165260.
106. Rotter V, Nagaev I, Smith U. Interleukin-6 (IL-6) induces insulin resistance in 3T3-L1 adipocytes and is, like IL-8 and TNF- α , overexpressed in human fat cells from insulin-resistant subjects. *J Biol Chem*. 2003; 278:45777-45784.
107. Senn JJ, Klover PJ, Nowak IA, Zimmer TA, Koniaris LG, Furlanetto RW, Mooney RA. Suppressor of cytokine signaling-3 (SOCS3), a potential mediator of interleukin-6 dependent insulin resistance in hepatocytes. *J Biol Chem*. 2003; 278:13740-13746.
108. Vozarova B, Fernandez-Real JM, Knowler WC, Gallart L, Hanson RL, Gruber JD, Ricart W, Vendrell J, Richart C, Tataranni PA, Wolford JK. The interleukin-6 (174) G/C promoter polymorphism is associated with type-2 diabetes mellitus in Native Americans and Caucasians. *Hum Genet*. 2003; 112:409-413.
109. Jiang CQ, Lam TH, Liu B, Lin JM, Yue XJ, Jin YL, Cheung BM, Thomas GN. Interleukin-6 receptor gene polymorphism modulates interleukin-6 levels and the metabolic syndrome: GBCS-CVD. *Obesity (Silver Spring)*. 2010; 18:1969-1974.
110. Fishman D, Faulds G, Jeffery R, Mohamed-Ali V, Yudkin JS, Humphries S, Woo P. The effect of novel polymorphisms in the interleukin-6 (IL-6) gene on IL-6 transcription and plasma IL-6 levels, and an association with systemic-onset juvenile chronic arthritis. *J Clin Invest*. 1998; 102:1369-1376.
111. Olivieri F, Bonafe M, Cavallone L, Giovagnetti S, Marchegiani F, Cardelli M, Mugianesi E, Giampieri C, Moresi R, Steconi R, Lisa R, Franceschi C. The -174 C/G locus affects *in vitro/in vivo* IL-6 production during aging. *Exp Gerontol*. 2002; 37:309-314.
112. Berthier MT, Paradis AM, Tchernof A, Bergeron J, Prud'homme D, Després JP, Vohl MC. The interleukin 6 -174G/C polymorphism is associated with indices of obesity in men. *J Hum Genet*. 2003; 48:14-19.
113. Wernstedt I, Eriksson AL, Berndtsson A, Hoffstedt J, Skrtic S, Hedner T, Hultén LM, Wiklund O, Ohlsson C, Jansson JO. A common polymorphism in the interleukin-6 gene promoter is associated with overweight. *Int J Obes Related Metab Disord*. 2004; 28:1272-1279.
114. Fernandez-Real JM, Broch M, Vendrell J, Gutiérrez C, Casamitjana R, Pugeat M, Richart C, Ricart W. Interleukin-6 gene polymorphism and insulin sensitivity. *Diabetes*. 2000; 49:517-520.
115. Fernandez-Real JM, Broch M, Vendrell J, Richart C, Ricart W. Interleukin-6 gene polymorphism and lipid abnormalities in healthy subjects. *J Clin Endocrinol Metab*. 2000; 85:1334-1339.
116. Kitamura A, Hasegawa G, Obayashi H, Kamiuchi K, Ishii M, Yano M, Tanaka T, Yamaguchi M, Shigeta H, Ogata M, Nakamura N, Yoshikawa T. Interleukin-6 polymorphism (-634C/G) in the promoter region and the progression of diabetic nephropathy in type-2 diabetes. *Diabet Med*. 2002; 19:1000-1005.
117. Villuendas G, San Millan JL, Sancho J, Escobar-Morreale HF. The -597 G→A and -174 G→C polymorphisms in the promoter of the IL-6 gene are associated with hyperandrogenism. *J Clin Endocrinol Metab*. 2002; 87:1134-1141.
118. Muller-Steinhardt M. Cooperative influence of the interleukin-6 promoter polymorphisms -597, -572 and -174 on long-term kidney allograft survival. *Am J Transplant*. 2004; 4:402-406.
119. Zawal L, Dai JL, Buckhaults P, Zhou S, Kinzler KW, Vogelstein B, Kern SE. Human Smad3 and Smad4 are sequence-specific transcription activators. *Mol Cells*. 1998; 1:611-617.
120. Chen H, Montagnani M, Funahashi T, Shimomura I, Quon MJ. Adiponectin stimulates production of nitric oxide in vascular endothelial cells. *J Biol Chem*. 2003; 278:45021-45026.
121. Maroni P, Bendinelli P, Picoletti R. Early intracellular events induced by *in vivo* leptin treatment in mouse skeletal muscle. *Mol Cell Endocrinol*. 2003; 201:109-121.
122. Ceddia RB, Somwar R, Maida A, Fang X, Bikopoulos G, Sweeney G. Globular adiponectin increases GLUT 4 translocation and glucose uptake but reduces glycogen synthesis in rat skeletal muscle cells. *Diabetologia*. 2005; 48:132-139.
123. Perez C, Fernandez-Galaz C, Fernandez-Agullo T, Arribas C, Andrés A, Ros M, Carrascosa JM. Leptin impairs insulin signalling in rat adipocytes. *Diabetes*. 2004; 53:347-353.
124. Aguirre V, Uchida T, Yenush L, Davis R, White MF. The c-Jun NH(2)-terminal kinase promotes insulin resistance during association with insulin receptor substrate-1 and phosphorylation of Ser(307). *J Biol Chem*. 2000; 275:9047-9054.
125. Kanety H, Feinstein R, Papa MZ, Hemi R, Karasik A. Tumor necrosis factor alpha-induced phosphorylation of insulin receptor substrate-1 (IRS-1). Possible mechanism for suppression of insulin-stimulated tyrosine phosphorylation of IRS-1. *J Biol Chem*. 1995; 270:23780-23784.
126. Gao Z, Hwang D, Bataille F, Lefevre M, York D, Quon MJ, Ye J. Serine phosphorylation of insulin receptor substrate 1 by inhibitor κ B kinase complex. *J Biol Chem*. 2002; 277:48115-48121.
-
- Received June 8, 2023; Revised July 18, 2023; Accepted July 25, 2023.
- Released online in J-STAGE as advance publication July 28, 2023.
- §These authors contributed equally to this work.*
- *Address correspondence to:*
Abhishek Gupta, Department of Physiology, King George's Medical University, Lucknow-226003, Uttar Pradesh, India.
E-mail: abhikgmu@gmail.com

Using eConsent to improve patient comprehension and solving issues for introduction, with special attention to the COVID-19 pandemic: A questionnaire survey by the Japan Pharmaceutical Manufacturers Association

Naoki Tomotsugu¹, Naoki Sakuma², Maki Dobashi³, Miki Someya⁴, Akiko Imai⁵, Junichi Sakoda⁶, Masashi Fukuda⁷, Katsuhiko Yoshimoto⁸, Tatsuo Iiyama¹

¹ National Center for Global Health and Medicine, Tokyo, Japan;

² Teijin Pharma Limited, Tokyo, Japan;

³ Kissei Pharmaceutical Co., Ltd., Tokyo, Japan;

⁴ Pfizer R&D Japan G.K., Tokyo, Japan;

⁵ Otsuka Pharmaceutical Co., Ltd., Tokyo, Japan;

⁶ Novartis Pharma K.K., Tokyo, Japan;

⁷ Sumitomo Pharma Co., Ltd., Tokyo, Japan;

⁸ Nippon Shinyaku Co., Ltd., Kyoto, Japan.

Abstract: The environment surrounding clinical trials is evolving rapidly with the advancement of digital transformation (DX). Especially during the COVID-19 pandemic, digital methods are effective in promoting multiregional clinical trials (MRCT). eConsent is an electronic tool for obtaining informed consent that is expected as a key solution to improve patient understanding. According to the report by Pietrzykowski *et al.*, patient understanding in clinical trials is surprisingly low, and this is a significant ethical problem. Despite the current situation, the use of eConsent has not significantly progressed at least in Japan. This study aimed to identify the current issues for eConsent and consider measures to solve them. In January 2022, an online questionnaire survey was sent to 69 member companies of the Japan Pharmaceutical Manufacturers Association (JPMA), and 52 companies (75.4%) responded. Thirteen companies (25.0%) conducted a trial using eConsent. Among the 13 companies, 17 trials were conducted by 8 companies during or after the COVID-19 pandemic (summer 2020), compared to 8 trials by 5 companies before the pandemic. We found that the biggest obstacles to the spread of eConsent are the lack of awareness of eConsent use and the development of provisions for treating electronic files as source records in medical institutions. In conclusion, we need to encourage medical institutions to update provisions for handling electronic source documents and to notify them of the importance of eConsent. Thus, further promotion of eConsent is needed to increase patient understanding and enable more efficient clinical trials.

Keywords: electronic signature, patient centricity, patient protection, decentralized clinical trial (DCT), multi-regional clinical trials (MRCT)

Introduction

The environment surrounding clinical trials is evolving rapidly with the advancement of digital transformation (DX) (1). Especially during an infectious emergency such as the COVID-19 pandemic, digital methods are effective in promoting multiregional clinical trials (MRCT). Furthermore, it is widely believed that in the near future, decentralized clinical trials (DCT) (2), in which clinical trials are conducted with subjects making few visits to medical institutions, will become a reality. Among the various technological developments,

eConsent is a vital component because it increases the participant's understanding of clinical trials and, in principle, enables remote informed consent (3).

In the Use of Electronic Informed Consent in Clinical Investigations - Questions and Answers published by the Food and Drug Administration (FDA) in 2016 (4), the importance of ensuring the rights, safety, and welfare of patients and improving their understanding of clinical trials was emphasized. However, Pietrzykowski *et al.* reported that the level of comprehension regarding informed consent components, such as voluntary participation, blinding, and freedom to withdraw, was

low, being understood by only 50% of patients (5). In light of the philosophy of the Declaration of Helsinki (6), this would seriously undermine the ethical basis of the current practice for obtaining informed consent in clinical trials.

Since eConsent can interactively combine not only documents but also various types of content such as animation, video, and audio, it can provide the necessary explanations for informed consent very effectively and is considered to be a method that greatly contributes to the improvement of the understanding of the participants. However, the traditional paper written informed consent requires the clinical research associates (CRAs) of the pharmaceutical company or the clinical research organization (CRO) to visit the research sites in person to confirm the original written consent form and related information, which is problematic in terms of efficiency and information management. Therefore, we believe that eConsent needs to be promoted more aggressively.

Despite the current situation, the use of eConsent has not progressed in Japan. We thought it necessary to understand the current situation more accurately to overcome this situation. Therefore, we conducted a questionnaire survey of all 69 pharmaceutical companies that belong to the Japan Pharmaceutical Manufacturers Association (JPMA) to investigate current practices and initiatives related to eConsent and to identify the issues that need addressing and measures that can be taken to solve them. Furthermore, the summer of 2020 was defined as the time when the first wave of the COVID-19 pandemic began, and Japan decided to postpone the Olympic Games by one year. Based on these experiences, many business behavior changes occurred during or after the summer of 2020, so we asked questions based on before, during or after the summer of 2020. We also asked if and why the COVID-19 pandemic affected the implementation of eConsent.

Materials and Methods

In January 2022, an online questionnaire was sent to 69 member companies of the JPMA. The questionnaire contents are shown in the Supplemental File (<https://www.ghmopen.com/site/supplementaldata.html?ID=66>). Responses to the questionnaire were provided once per company. The first question (the trigger question) asked the participants about their previous experience with eConsent implementation; and the subsequent question was based on their answer. The answer choices for the trigger questions included: [1] Studies were conducted with eConsent (*e.g.*, eConsent was used for informed consent in actual studies), [2] Challenges for the introduction of eConsent were made (*e.g.*, selection of eConsent vendors and so on), but actual studies were not conducted with eConsent, and [3] No studies were conducted or considered with eConsent.

To elicit free and candid opinions when responding

to the questionnaire, free-text responses were allowed. We extracted the essence of these free-text responses, categorized and tabulated them. To avoid personal bias, all categorizations were repeatedly reviewed by all the authors until everyone agreed.

For companies that responded to the trigger question with answer choice [1] studies were conducted with eConsent: We asked about their experience with "hybrid operations" and the number of studies they conducted in such manner. Here, "hybrid operation" means that all studies did not necessarily operate only electronically, such as using paper or electronic consent for some sites, or using paper only for consent signature.

Companies that responded that they used "hybrid operations" were asked about their experience using paper only for consent signatures, including the number of studies conducted and the reasons why paper was used only for consent signatures.

Among the eConsent studies, we asked whether they were conducted before the COVID-19 pandemic (summer 2020), the number of studies conducted, their study phase (I, II, III, IV, PMS, and others), and whether the studies were Japanese domestic or international collaborative studies. We also asked the same question during or after the COVID-19 pandemic (summer 2020). As we described in the introduction, in this study, we set summer 2020 as the starting point for "the COVID-19 pandemic" because the first wave of the COVID-19 pandemic began in Japan, and the Japanese government decided to postpone the Olympic Games by one year. Based on these experiences, many business behavior changes occurred after the summer of 2020. We also defined the "during or after COVID-19 pandemic" period as the period from the summer of 2020 through the end of 2021, when the questionnaire survey was conducted.

For companies that responded to the trigger question with answer choice [1] Studies were conducted with eConsent or [2] Considerations for introducing eConsent were made, but actual studies were not conducted with eConsent: When conducting (or considering) studies with eConsent, we asked about any issues encountered and their details. We asked if there was anything that should be improved with eConsent and what and how it should be improved.

For companies that responded to the trigger question with answer choice [3] No studies were conducted or considered with eConsent: We asked why they had not conducted or considered studies with eConsent.

For all companies: We asked if they would use (or consider using) eConsent in the future, and why.

Results

The online questionnaire survey on eConsent was sent to 69 JPMA companies between January 5, 2022 and January 25, 2022, and 52 companies (75.4%) responded.

When asking companies about their eConsent

experience (the trigger question) we found that [1] 13 companies (25.0%) had conducted studies using eConsent, [2] 7 companies (13.5%) considered the introduction of eConsent (e.g., the selection of eConsent vendors was considered), but actual studies were not conducted with eConsent, and [3] 32 companies (61.5%) did not conduct or consider studies using eConsent (Figure 1).

For the 13 companies that responded to the trigger question with answer choice [1] Studies were conducted with eConsent

When asked about their experience with "hybrid operations" and the number of studies they conducted, 12 companies had experience with hybrid operations, with an average of 1.8 hybrid studies (maximum 6, minimum 1) per company. Only one company operated completely electronically.

When the 12 companies that responded that they had experience with "hybrid operations" were asked about their experience using paper only for consent signatures, nine companies used paper only for consent signatures, and the average number of studies was 1.4 (maximum 3, minimum 1). The reasons given for using paper only for consent signatures were "sites' implementation for eConsent is not in place" (4 companies), "site specific forms" (3 companies), "concerns about personal information protection" (3 companies), "pilot trials" (2 companies), "concerns about obtaining electronic consent (companies)" (2 companies), and "time constraints". The reasons for using paper only for consent signatures are shown in Table 1.

Of the 13 companies that used eConsent, 5 companies used it for 8 studies before the COVID-19 pandemic (summer 2020), compared to 8 companies

and 17 studies during or after the COVID-19 pandemic (summer 2020). Before the COVID-19 pandemic, there were 0, 2, and 6 studies for phases I, II, and III, respectively. During or after the COVID-19 pandemic (summer 2020), there were 3, 3 and 11 studies for Phase I, II, and III respectively. In addition, before the COVID-19 pandemic, there were 2 studies in Japan and 6 studies internationally. During or after the COVID-19 pandemic (summer 2020), there were 4 studies in Japan and 13 studies internationally. The number of studies using eConsent before, and during or after the COVID-19 pandemic (summer 2020) is shown in Table 2.

For the 20 companies that responded to the trigger question with answer choices [1] Studies were conducted with eConsent (13 companies) and [2] Considerations for introducing eConsent were made, but actual studies were not conducted with eConsent (7 companies)

When conducting (or considering) studies with eConsent,

Table 1. The reasons given for using paper only for consent signatures

Reason	Frequency (multiple answers allowed) <i>n</i> = 9
Sites' implementation for eConsent is not in place	4
Site specific forms	3
Concerns about personal information protection	3
Pilot trials	2
Concerns about obtaining electronic consent (companies)	2
Time constraints	1
Total	15

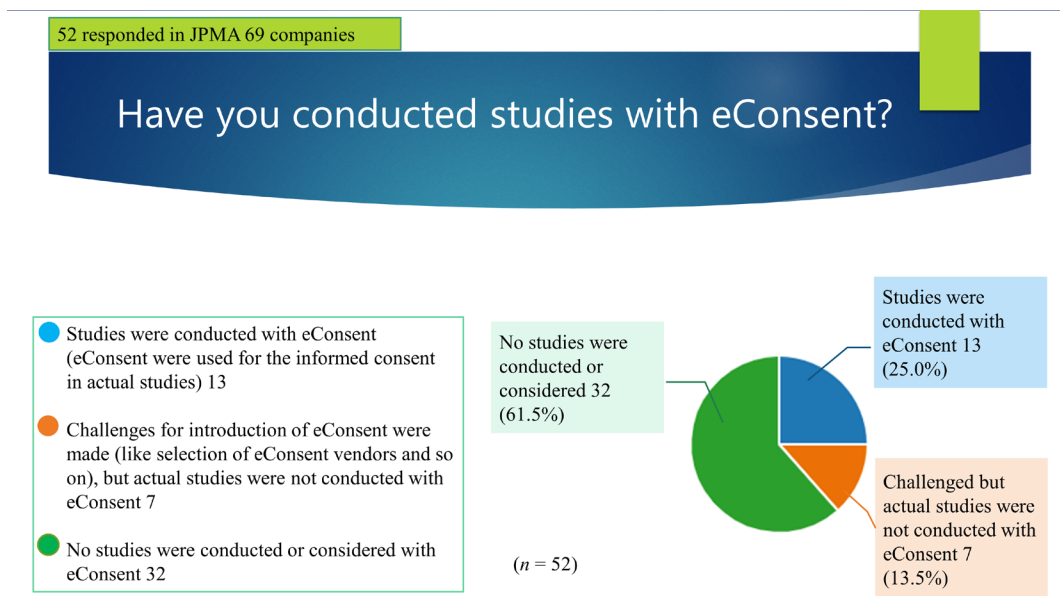

Figure 1. The online questionnaire survey on eConsent for 52 JPMA companies between January 5, 2022 and January 25, 2022.

14 companies in the 20 companies of [1] and [2] said they encountered some issues, and 6 said they did not. [1] The 14 companies that used eConsent reported the following issues, with the number of companies reporting that issue: system (language): 2, systems (individual customization): 2, sites' implementation for eConsent is not in place: 2, communications environments: 2, cost: 1, content issues (not suitable for Japan): 1, system (bug): 1, installation schedule: 1, inability to fully comply with Japanese regulatory requirements electronic records/electronic signatures (ER/ES): 1, lack of understanding of monitors: 1, patient request (if symptoms make it impossible to operate, patients request paper-based informed consent): 1, concern about personal information protection by company: 1, and site-specific form: 1. On the other hand, [2] the seven companies that considered introducing eConsent, but did not conduct studies with

eConsent reported the following issues: system (bug): 1, sites' implementation for eConsent is not in place: 1, cost: 2, concern about BYOD (bring your own device support): 1, benefits are reduced by half due to hybrid operations: 1, and not seeing the significance of eConsent as it requires face-to-face signatures: 1. Details of the issues encountered when introducing eConsent are presented in Table 3.

When these 20 companies were asked if there were any improvements to be made in relation to eConsent, 17 companies said there were points to be improved, and 3 companies said there were no points to be improved. The following details for improvements were suggested, followed by the number of companies reporting that suggestion. [1] The 13 companies that conducted studies with eConsent reported the following: a lack of coordination of awareness of eConsent use (sponsors/medical institution): 5, eConsent systems were not up to the required level in Japan: 5, the cost of introduction was high: 3, guidelines were not developed: 2, systems take a long time to build: 2, sites' implementation of eConsent is not in place: 2, remote consent should be allowed with video calls: 1, cost of device rentals is significant: 1, system errors are frequent: 1, and the process of re-consent with eConsent is complicated: 1. On the other hand, [2] the seven companies that considered introducing eConsent, but did not conduct studies with eConsent reported the following: a lack of coordination of awareness of eConsent use (sponsors/medical institution): 2, eConsent systems were not up to the required level in Japan: 2, the cost of introduction was high: 1, guidelines were not developed: 1, systems take a long time to build: 1, and remote consent should

Table 2. The number of studies using eConsent before, and during or after the COVID-19 pandemic (summer 2020)

Study phase / type	Before COVID-19 Pandemic (Summer 2020) (5 Companies)	During or after COVID-19 Pandemic (Summer 2020) (8 companies)
Phase I (Japan only)	0	2
Phase I (International)	0	1
Phase II (Japan only)	1	1
Phase II (International)	1	2
Phase III (Japan only)	1	1
Phase III (International)	5	10
Total	8	17

In this study, we set the summer 2020 as the starting point for "the COVID-19 pandemic". We also defined the "after COVID-19 pandemic" period as the period from the summer 2020 through the end of 2021, when the questionnaire survey was conducted.

Table 3. Issues encountered when introducing eConsent

Details of Issues	(1) Companies that conducted studies with eConsent (Multiple answers allowed) <i>n</i> = 13	(2) Companies that considered introducing eConsent, but actual studies were not conducted with eConsent (multiple answers allowed) <i>n</i> = 7
System (Language)	2	1
System (Individual customization)	2	
Sites' implementation for eConsent is not in place	2	1
Communications environments	2	
Cost	1	2
Content issues (not suitable for Japan)	1	
System (bug)	1	
Installation schedule	1	
Inability to fully comply with Japanese regulatory requirements (ER/ES) that is developed based on 21 CFR Part 11	1	
Lack of understanding of monitors	1	
Patient's request (if symptoms make it impossible to operate, patients request paper-based informed consent)	1	
Concern about personal information protection by company	1	
Site specific form	1	
Concern about BYOD support		1
Benefits are reduced by half due to hybrid operations		1
Not seeing the significance of eConsent as it requires face-to-face signatures.		1
Total	17	7

BYOD, bring your own device; CFR, Code of Federal Regulations, ER/ES, electronic records/electronic signatures

be allowed with video calls: 1. The points to be improved are listed in Table 4.

Five companies reported that the COVID-19 pandemic had an impact on their eConsent implementation, however, 15 companies reported no impact. Companies that reported an impact cited the use of eConsent to prevent infection among the medical staff, and the pandemic promoted the use of DCT as the main reasons. However, companies that did not report the impact of the pandemic indicated that eConsent had been in place before the pandemic and did not change much after the pandemic, as in-person consent signatures were still required in most cases.

For the 32 companies that responded to the trigger question with answer choice [3] Did not conduct or consider studies with eConsent

When we asked why they had not conducted studies with eConsent in the past, the reasons included lack of necessity, regulatory challenges, cost, support for elderly patients, overseas initiative, lack of experience among Japanese CROs, and time constraints.

For all companies (52 companies)

When asked whether they would use (or are considering using) eConsent in the future and why, [1] all 13 companies that conducted studies using eConsent answered that they would consider using eConsent in the future, citing the following reasons: realization of DCT: 6, monitoring industry trend: 3, compatibility with studies: 2, improved understanding of subjects: 2, making efficient study management tasks: 1 (management of informed consent form (ICF) versions and consent acquisition status), establishment of site implementation for eConsent: 1, and improvement of clinical trial efficiency: 1. Six of [2] the seven companies that considered introducing eConsent, but did not conduct studies with eConsent reported that they would consider using eConsent in the future for the following reasons: realization of DCT: 2,

compatibility with studies: 1, improved understanding of participants: 2, making efficient study management tasks: 1 (management of ICF versions and consent acquisition status), development of guidelines: 2, consideration in a global implementation trial: 1, clarification of user benefits: 1, and cost benefits: 1. One of [2] the seven companies that considered introducing eConsent, but did not conduct studies with eConsent reported that they would not consider using eConsent in the future, and the reason for this was that face-to-face informed consent is indispensable. Furthermore, 21 of [3] the 32 companies that responded that they did not conduct a trial or were not considering eConsent reported that they would consider using eConsent in the future, with the main reasons cited as realization of DCT: 7, monitoring industry trend: 6, reduced burden on subjects: 4, improved understanding of subjects: 3, making efficient study management tasks (management of ICF versions and consent acquisition status): 6, and cost benefits: 2. Eleven of [3] the 32 companies that responded that they had not conducted a trial or were not considering eConsent reported that they would not consider using eConsent in the future due to the following: monitoring industry trend: 1, compatibility with studies: 2, cost disadvantage: 2, overseas initiative: 2, no clinical trial: 2, no necessity: 2, must be implemented in combination with online medical care to be beneficial: 1, burden on organization from the introduction of new technology (securing resources for consideration): 1, and delayed response to digitization: 1. The future plan for eConsent and its reasons are listed in Table 5.

Discussion

Our study has four major findings. First, although our study showed that the number of studies with eConsent increased before, and during or after the COVID-19 pandemic (summer 2020), the study participants reported that the pandemic did not significantly affect the implementation of eConsent. Second, the results suggest that raising the awareness of eConsent in medical

Table 4. Points to be improved

Points to be improved	(1) Companies that conducted (2) Companies that considered introducing studies with eConsent (Multiple eConsent, but actual studies were not conducted answers allowed) <i>n</i> = 13	
		with eConsent (multiple answers allowed) <i>n</i> = 7
Lack of coordination of awareness of eConsent use (sponsors / medical institution)	5	2
eConsent systems were not up to the required level in Japan	5	2
The cost of introduction was high	3	1
Guidelines were not developed	2	1
Systems take long time to build	2	1
Sites' implementation for eConsent is not in place	2	
Remote consent should be allowed with video calls	1	1
Cost of device rentals is significant.	1	
System errors are frequent	1	
Process of re-consent with eConsent is complicated	1	
Total	23	8

institutions is vital. Third, the cost of using eConsent is one of the major issues preventing pharmaceutical companies from introducing eConsent. Fourth, our results indicated that the most of the hybrid operations used paper only for consent signatures.

COVID-19 pandemic effects on the use of eConsent

An online questionnaire on eConsent was sent to 69 companies of the Japan Pharmaceutical Manufacturers Association on January 5, 2022, and 52 companies (75.4%) responded. This study reconfirmed that use of eConsent is not widespread, at least in Japan. For the 20 companies that responded to the trigger question with answer choices [1] studies were conducted with eConsent (13 companies) and [2] considered the introduction of eConsent, but actual studies were not conducted with eConsent (7 companies), we have shown that 5 companies indicated that the COVID-19 pandemic affected their eConsent implementation, and 15 companies indicated that it did not. One of the companies that indicated that the pandemic did affect their eConsent implementation cited the prevention of infection among

medical staff as their reason.

However, even when eConsent was used, the results of this study show that, at present, there are many instances of face-to-face use of eConsent. Although eConsent reduces the time of direct contact with patients, there is still a certain amount of face-to-face time; therefore, its significance in preventing infection is considered to be limited.

On the other hand, several companies reported that the COVID-19 pandemic had no impact on them and cited the fact that they had been working on eConsent before the COVID-19 pandemic and were currently obtaining informed consent with eConsent face-to-face as the reasons. The number of companies that reported no impact of eConsent implementation was three times greater than those that did.

Although the COVID-19 pandemic may have affected people's mindset, the global trend toward digitalization began before the COVID-19 pandemic, and the increase in the number of eConsent implementations observed during or after the COVID-19 pandemic was considered consistent with this major trend toward digitalization. As the trend toward digitalization is expected to continue,

Table 5. Whether companies would use (or are considering using) eConsent in the future and why

Would you consider using eConsent in the future? (Y/N)	(1) Companies that conducted studies with eConsent (Multiple answers allowed) n = 13		(2) Companies that considered eConsent, but actual studies not conducted with eConsent (multiple answers allowed) n = 7		(3) Companies that did not conduct or consider eConsent studies with eConsent (n = 32)	
	Y (n = 13)	Y (n = 6)	N (n = 1)	Y (n = 21)	N (n = 11)	
Realization of decentralized clinical trial (DCT)	6	2		7		
Monitoring industry trend	3			6	1	
Compatibility with studies	2	1		2	2	
Improved understanding of subjects	2	2		3		
Making efficient of study management tasks (management of informed consent form versions and consent acquisition status)	1	1		6		
Establishment of sites' implementation for eConsent	1			1		
Improvement of clinical trial efficiency	1					
Development of guidelines		2		1		
Consideration in a global implementation trial		1				
Clarification of user benefits		1				
Cost benefits		1		2		
Cost demerit						2
Cost unknown				1		
Face-to-face informed consent is indispensable			1			
Reduced burden on subjects				4		
Overseas initiative				1	2	
Expanding options for subjects				1		
Improved engagement with subjects				1		
No clinical trial						2
No necessity						2
Must be implemented in combination with online medical care to be beneficial						1
Burden on organization from introduction of new technology (securing resources for consideration)						1
Delayed response to digitization						1
Total	16	11	1	36	14	

we believe that the introduction of eConsent will be further promoted in the future. Of the 52 companies that responded, 40 said that they would continue to consider adopting eConsent for DCT in the future, revealing high expectations for future DCT, reducing the burden on participants, increasing participant understanding, and conducting more efficient clinical trials. Therefore, we believe that the promotion speed of eConsent needs to be accelerated within industry, government, and academia for the appropriate and efficient conduct of clinical trials.

Raising awareness in medical institutions

Our results repeatedly pointed out that one of the major impediments to the implementation of eConsent was the acceptance of medical institutions and the development of standard operating procedures (SOPs) or provisions in medical institutions (Tables 1, 3, 4, and 5). Even if pharmaceutical companies tried to promote eConsent, there seems to be many cases where it was not acceptable to use electronic documents and signatures as source records because it is expected that the SOPs or provisions in medical institutions stipulate that the source records should be paper. eConsent can be seen as a significant benefit to medical institutions. In addition to protecting participants and promoting better understanding, consent forms or records can be managed online and are less likely to be lost. They can also manage online which participants have given re-consent and which have not, such as version control, when re-consent is required, thus enabling efficient management. The audit trail is automatically captured, including login information, time spent reading materials, time signed, and question exchanges. Furthermore, it allows the reduction of the response time to source data verification (SDV) by pharmaceutical companies or CRO and reduces the paper storage space. In fact, when you experience an electronic file as a source record, you do not want to return to the paper world. Therefore, it is necessary for the pharmaceutical industry and academia to enlighten medical institutions about the significance of eConsent, improve their understanding of the subject, and propose concrete measures for improvement, such as proposing a model for propositions or SOPs that allow electronic files as source records.

eConsent Installation Cost

This study showed that there are different opinions and positions on the installation cost of eConsent (Tables 3, 4, and 5). Some companies reported that eConsent was expensive, while others reported that they could save money by making it more efficient. The conflicting reasons could depend on how each company views eConsent and how the studies are conducted. In the raw data from the survey responses, there were some cases where it was functionally inadequate, such as the lack

of support for Japanese fonts, some systems were not considered to be able to withstand the detailed demands of each site, and that it was not worth the cost or the effort. From the point of view of vendors providing eConsent, it is possible that the level of functionality required by the industry is not consistent, resulting in price instability. Although some aspects of eConsent alone may not be worth the cost at the present time, using eConsent may be necessary when considering increasing participant's understanding, industry-wide improvements in the monitoring efficiency and overall clinical trial scheme and the future of DCT.

Regulatory for eConsent

Our study found that of the 13 companies that said they used eConsent, 9 used it face-to-face, and consent forms were paper-signed in hybrid operations.

The administrative notification of the Pharmaceutical Evaluation and Licensing Division and Medical Devices Evaluation and Licensing Division, the Ministry of Health, Labour and Welfare, dated April 7, 2022 (7) states that, "In the case that a clinical trial is to be conducted on patients with infectious diseases, including novel coronavirus infection, and it is difficult to preserve the signed consent documents from the viewpoint of contagiousness of the disease, *etc.*, according to the protocol or hospital regulations, if a patient signs the consent document in his/her own handwriting using a tablet device and it is stored electromagnetically", with reference to the "Use of electromagnetic records and electronic signatures in applications for approval or permission for drugs, *etc.*" (8), the document can be treated as a source record, provided that a procedure manual is in place on how to preserve the document, the document is preserved in a readable condition, and a copy of the consent document (*e.g.*, an output of electromagnetic record) is delivered to the subject in accordance with Article 53 of the "Pharmaceutical GCP Ministerial Ordinance, Article 73 of the Medical Device GCP Ministerial Ordinance", or Article 73 of the "Regenerative Medicine GCP Ministerial Ordinance". This information shows the direction of accepting electronic files signed on tablets as source records. The results in Table 1 also show that there were only two companies with concerns about obtaining electronic informed consent, which suggests that pharmaceutical companies do not have major concerns about having an electronic file signed on a tablet as the source record.

In December 2021, the Cabinet Office Council for Promotion of Regulatory Reform issued a report entitled "Immediate Regulatory Reform Implementation Items" (9), which says "guidance should be developed on appropriate methods for physicians at the investigational sites to provide necessary explanations to subjects about the clinical trial and to obtain informed consent non-face-to-face and remotely, and on ensuring the

reliability of the data". On March 30, 2023, the Japanese government issued the guidance "Points to Consider for the Informed Consent Using Electromagnetic Methods in Clinical Trials and Post-Marketing Studies" (10) for the implementation of eConsent, we hope that eConsent should become more widespread and implemented.

The limitation of the study is that the questionnaire survey in this study covers only JPMA member companies and does not reflect the opinions of other pharmaceutical companies, medical institutions, or participants.

Conclusion

This study revealed that eConsent is not widely used at least in Japan. It also discovered that one of the reasons why eConsent is not widely used is that medical institutions have not developed their provisions or SOPs to treat electronic files as source records. Since eConsent will help patients to better understand and enable more efficient clinical trials, we need to enlighten medical institutions about the significant merit of eConsent and promote the widespread use of eConsent.

Acknowledgements

The authors thank the Japan Pharmaceutical Manufacturers Association (JPMA) and colleagues in the member companies for their timely cooperation in completing the survey.

Funding: This research was supported by the Japan Pharmaceutical Manufacturers Association (JPMA) and the intramural research fund of the National Center for Global Health and Medicine (NCGM).

Conflict of Interest: The authors have no conflicts of interest to disclose.

References

1. Inan OT, Tenaerts P, Prindiville SA, Reynolds HR, Dizon DS, Cooper-Arnold K, Turakhia M, Pletcher MJ, Preston KL, Krumholz HM, Marlin BM, Mandl KD, Klasnja P, Spring B, Iturriaga E, Campo R, Desvigne-Nickens P, Rosenberg Y, Steinhubl SR, Califf RM. Digitizing clinical trials. *NPJ Digit Med.* 2020; 3:101.
2. Pennestri F, Banfi G, Tomaiuolo R. Remote decentralized clinical trials: a new opportunity for laboratory medicine. *Clin Chem Lab Med.* 2023 Jan 5. doi: 10.1515/cclm-2022-

- 1184.
3. Vanaken H Ir, Masand SN. Awareness and collaboration across stakeholder groups important for eConsent achieving value-driven adoption. *Ther Innov Regul Sci.* 2019; 53:724-735.
4. U.S. Food & Drug. Use of electronic informed consent in clinical investigations – questions and answers. December, 2016. <https://www.fda.gov/regulatory-information/search-fda-guidance-documents/use-electronic-informed-consent-clinical-investigations-questions-and-answers> (Accessed April 1, 2023).
5. Pietrzykowski T, Smilowska K. The reality of informed consent: Empirical studies on patient comprehension-systematic review. *Trials.* 2021; 22:57.
6. World Medical Association. WMA Declaration of Helsinki - Ethical Principles for Medical Research Involving Human Subjects. <https://www.wma.net/policies-post/wma-declaration-of-helsinki-ethical-principles-for-medical-research-involving-human-subjects/> (Accessed April 1, 2023).
7. The Ministry of Health, Labour and Welfare, Division of Medical Device Review and Administration. Handling of Preservation of Consent Documents in Clinical. *Trials* April 7, 2022. https://www.mhlw.go.jp/web/t_doc?dataId=00tc4962&dataType=1&pageNo=1 (Accessed April 1, 2023). (in Japanese)
8. Director General, Pharmaceutical and Food Safety Bureau, the Ministry of Health, Labour and Welfare, PFSB Notification No. 0401022. Use of electromagnetic records and electronic signatures in applications for approval or permission of pharmaceuticals, etc. (ER/ES Guidelines). April 1, 2005. <https://www.pmda.go.jp/files/000158308.pdf> (Accessed April 1, 2023). (in Japanese)
9. Cabinet Office Regulatory Reform Promotion Council. Immediate Regulatory Reform Implementation Items. December, 2021. <https://www8.cao.go.jp/kisei-kaikaku/kisei/publication/opinion/211222.pdf> (Accessed April 1, 2023). (in Japanese)
10. The Ministry of Health, Labour and Welfare. Points to Consider for the Informed Consent Using Electromagnetic Methods in Clinical Trials and Post-Marketing Studies, March 30, 2023. <https://www.jmha.or.jp/jmha/news/info/13797> (Accessed April 1, 2023). (in Japanese)

Received January 15, 2023; Revised April 12, 2023; Accepted May 17, 2023.

Released online in J-STAGE as advance publication June 15, 2023.

*Address correspondence to:

Naoki Tomotsugu, Department of International Trials, Center for Clinical Trials, National Center for Global Health and Medicine, 1-21-1, Toyama, Shinjuku, Tokyo 162-8655, Japan.
E-mail: ntomotsugu@hosp.ncgm.go.jp

Alpha and Delta variants and vaccination effectiveness against severity in COVID-19 inpatients based on medical claims in Japan

Shingo Mitsushima^{1,*}, Hiromasa Horiguchi², Kiyosu Taniguchi^{3,4}

¹ Center for Field Epidemic Intelligence, Research and Professional Development, National Institute of Infectious Diseases, Tokyo, Japan;

² Department of Clinical Data Management and Research, Clinical Research Center, National Hospital Organization Headquarters, Tokyo, Japan;

³ National Hospital Organization Mie National Hospital, Mie, Japan;

⁴ The Tokyo Foundation for Policy Research, Tokyo, Japan.

Abstract: Some mutated strains of severe acute respiratory syndrome coronavirus 2 (SARS-CoV-2) presumably have high infectivity and pathogenicity. Using Japanese medical claims data, we assessed the pathogenicity of Alpha and Delta variants and vaccine effectiveness by severity. Inpatient records from the Medical Information Analysis Databank for the National Hospital Organization were used. Severity was defined as the proportion of inpatients using respiratory ventilators among inpatients with oxygen administration. We regressed severity and fatality on the proportion of patients with Alpha or Delta variant and on vaccination coverage, while allowing for some lag to reflect development from infection to hospitalization. We also examined results obtained when using data for all new inpatients, instead of inpatients with oxygen administration, as the denominator for severity. Estimation results were better when using severity defined by inpatients with oxygen administration as the denominator than when using all new inpatients. Especially for severity measures for inpatients 65 years old or older with oxygen administration, we confirmed an association of vaccination with lower severity and an association of Delta variant infection with high severity. Vaccines were most effective for people 65 years old or older. The age distributions of inpatients and confirmed patients were greater than for people younger than 65 years old. Vaccination reduced severity and fatality and Alpha and Delta variants might increase severity and fatality among inpatients 65 years old or older receiving oxygen therapy.

Keywords: COVID-19, mutated strains, fatality, medical claim data, vaccine

Introduction

Severe acute respiratory syndrome coronavirus 2 (SARS-CoV-2) causes coronavirus disease 2019 (COVID-19). COVID-19 spread throughout Japan from January 2020. The number of COVID-19 patients increased and decreased due to individual infection prevention and some political policies such as a state of emergency (1-4).

Some mutated strains such as Alpha and Delta variants including B.1.1.7 (Alpha variant) and B.1.617.2 (Delta variant) are likely to induce severe symptoms (5-7). In Japan, an epidemic of the Alpha variant occurred from March 2021 (Weeks 9-13, Wave 4). An epidemic of the Delta variant was reported from July 2021 (Weeks 27-30, 2021, Wave 5).

Development of vaccination against SARS-CoV-2 was initiated around the world after the emergence of COVID-19 (8). Vaccination in Japan started from 17 February 2021 (Week 7, 2021, Wave 3) using BNT162b2 mRNA (Pfizer Inc., BioNTech SE) and mRNA-1273 (Moderna, Inc.). Clinical trials proved the vaccines' efficacy for preventing infection against Alpha and Delta

variants (9). Therefore, the object of this study was evaluation of the severity of Alpha and Delta variants while considering vaccine effectiveness.

Japan's National Hospital Organization (NHO), an organization of regional core hospitals and 140 medical facilities with about 52,000 beds, represents about 3.4% of all beds in Japan (10). The NHO provides a database, the Medical Information Analysis Databank (MIA), which contains medical claims from 60 representative NHO hospitals, including data related to the numbers of inpatients and outpatients, diagnoses, medical interventions including oxygen administration and the use of respiratory ventilators, in addition to outcomes such as discharge and death (11). Representative 60 hospitals were the hospitals whose data on medical claim were available as MIA data at the beginning of this study. They locate in each region and we regarded and assumed that they are representative of patients in each region. The database does not include data related to the vaccination history or causative strain. COVID-19 had a significant impact on the medical setting for outpatients and inpatients (12-14). The number of patients of COVID-19

increased rapidly from July 2021 (Weeks 26–30, 2021, Wave 5) because of the spreading Delta variant. In the period during which the Delta variant spread, nationwide demand for medical resources such as hospital beds and respiratory ventilators threatened to exceed the capacity of medical resources allocated for COVID-19 patients. Therefore, asymptomatic patients and some patients with mild symptoms were not hospitalized during that period, even though such patients had been hospitalized earlier during the pandemic. In other words, the COVID-19 patient criteria for hospitalization changed to reflect the outbreak scale and the available capacity of medical resources. For that reason, when examining COVID-19 pathogenicity, the fraction of patients with severe symptoms or cases of fatality beyond the hospitalized cases might not be appropriate to evaluate pathogenicity because the criteria for hospitalization were not constant. The criteria were not based solely on medical necessity. To avoid inconsistency in the data, the number of hospitalizations had to be adjusted. Therefore, this study specifically examined patients who required oxygen therapy.

Materials and Methods

Data source

This study used MIA data from the NHO such as the number of inpatients with oxygen therapy, ventilation, and deaths from 1 January 2020 (Week 1, 2020, Wave

1) to 21 November 2021 (Week 46, 2021, Wave 5). All MIA data for patients were counted based on the week of admission.

Additionally, we used background COVID-19 patient data nationwide, including the number of newly confirmed patients and deaths, published between 1 January 2020 (Week 1, 2020, Wave 1) and 21 November 2021 (Week 46, 2021, Wave 5) from the Ministry of Health, Labour and Welfare (MHLW) (15). Hereinafter, we designate data from MHLW as "national data". Data related to vaccine administration (such as the number of people receiving at least one dose, which means one or two doses, and those who had received the second dose) were published by the Cabinet Secretariat (16). For the study period, the third and subsequent doses were not available. Data related to the Alpha and Delta variants were referred from a monitoring meeting in Tokyo (17).

Definition of waves

As of November 2021, Japan experienced five waves, which mean movements of the number of COVID-19 patients shown as Figure 1. In this study, the COVID-19 outbreak waves in Japan were classified by the number of newly confirmed patients from the trough of the prior wave to the trough of the current wave (4). That method clearly distinguished five waves through the end of November 2021: the wave 1 extended from week 1 of 2020 through week 23 of 2020; the wave 2 lasted from week 24 of 2020 through week 39 of 2020; the wave 3

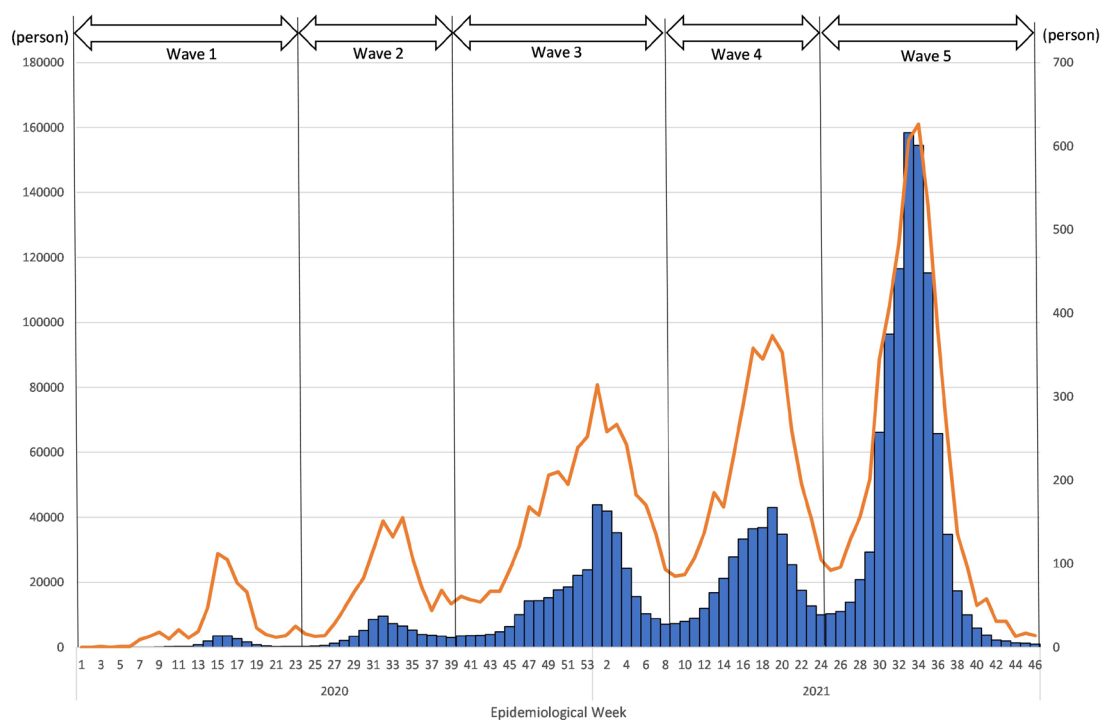

Figure 1. Newly confirmed COVID-19 patients in national data and new COVID-19 hospitalizations in MIA data. Notes: Bars show the numbers of newly confirmed COVID-19 patients in national data (left scale). The line shows the numbers of new COVID-19 hospitalizations in MIA data (right scale).

was recorded from week 40 of 2020 through week 8 of 2021; the wave 4 occurred from week 9 of 2021 through week 24 of 2021; and the wave 5 was from week 25 of 2021 through week 46 of 2021.

Design

Associations between the severity or fatality rate among inpatients with oxygen therapy and the vaccination coverage and/or the proportions of Alpha and Delta variants were examined. Additionally, we sought to ascertain the most appropriate length from infection to hospitalization by adjusting the delay in the timing of vaccination coverage two weeks prior and the proportions of Alpha and Delta variants. Specifically, we examined no delay and 1–4 or more weeks' delay. For no delay, vaccination coverage was recorded for two weeks before hospitalization; the proportions of Alpha and Delta variants were measured the same week of hospitalization. For 1–4 weeks' delay, the vaccination coverage 3–6 weeks before hospitalization or the proportions of Alpha and Delta variants were measured at 1–4 weeks before hospitalization.

The study period for analysis was from the first week of 2021 (Wave 1) through the 46th week of 2021 (Wave 5) because vaccination against COVID-19 had not started and Alpha and Delta variants had not emerged before the study period.

Definitions

Patients were limited to hospitalized patients with a COVID-19 infection confirmed by PCR test or antigen test and those who received oxygen therapy during their hospitalization. It is noteworthy that the timing of oxygen therapy did not matter: only that it was administered during their hospitalization. Furthermore, comorbidities did not matter for the patient definitions or outcome measures presented below.

The severity rate among patients was defined as the number of patients with ventilation during their hospitalization among patients who were admitted during a week, by the number of patients administered oxygen therapy who had been admitted during the same week. The timing of ventilation use did not matter: only that it was administered their hospitalization. The fatality rate among patients was defined as the number of fatalities among patients who were admitted in a week, divided by the number of patients administered oxygen therapy who had been admitted during the same week. The main or direct cause of death does not matter: only that they had been diagnosed as COVID-19-infected.

Hypothesis

Results of earlier studies have demonstrated that vaccination decreased severity and fatality rates. They

have also demonstrated that Alpha and Delta variants are associated with increased severity and higher fatality rates (5-7,18,19). Therefore, we expected to find a positive association among severity, fatality, and vaccination, and a negative association for the proportion of Alpha and Delta variants.

Statistical analysis

We applied ordinary least squares regression, with dependent variables of the severity rate among patients with oxygen therapy and the fatality rate among patients who had received oxygen therapy. Vaccination coverage and the proportions of Alpha and Delta variants were used as explanatory variables.

Statistical analyses were also performed after patient data were divided into those for age groups, with patients who were 65 years old or older and patients younger than 65 years. First, we identified the optimal period from infection to hospitalization for all ages, and by age classification, by outcome, severity rate, and fatality rate. Then, we discussed estimation results under the optimal period for each category. We adopted 5% as the significance level. All statistical analyses were conducted using software (STATA SE 17.0; Stata Corp.).

Ethical considerations

This study was approved by the Ethics Committee of Mie Hospital (Approval No. 2020-89). Permission to use MIA data was obtained from the NHO (Registration No. 1201003).

Results

Figure 1 presents the number of newly confirmed COVID-19 patients from national data and the number of new COVID-19 hospitalizations from MIA data. Figure 2 presents the number of fatalities attributed to COVID-19 from national data and the number of fatalities from MIA data. The number of newly confirmed COVID-19 patients from national data was shown by the diagnosed week. The number of new hospitalizations from MIA data is shown by the hospitalized week. The numbers of fatalities from national data and MIA data are shown by their death and discharge weeks. Vertical lines in Figures 1–5 represent periods between waves. Figure 1 shows similar trends obtained from the number of newly confirmed COVID-19 patients and the number of newly hospitalized patients. Figure 2 also shows that the number of fatalities from national data presents a similar trend to that of the number of fatalities from MIA data. Correlation between them was 0.8830, which was inferred as significant. The wave 5 showed the greatest number of newly confirmed cases (Figure 1). The wave 4 showed the greatest number of fatalities (Figure 2).

Figure 3 and Figure 4 respectively portray the

severity rate with ventilator usage among patients with oxygen therapy and the fatality rate among patients with oxygen therapy for all ages, and by age classification. At first glance, all lines were declining in the latter period of the study period when bottom from wave 5 to 6. Figure

5 shows vaccination coverage with at least one dose in the entire population, younger than 65 years old, and 65 years old or older, in addition to the proportions of Alpha and Delta variants in Tokyo. The proportions of the Delta variant showed a similar increase to that of vaccination

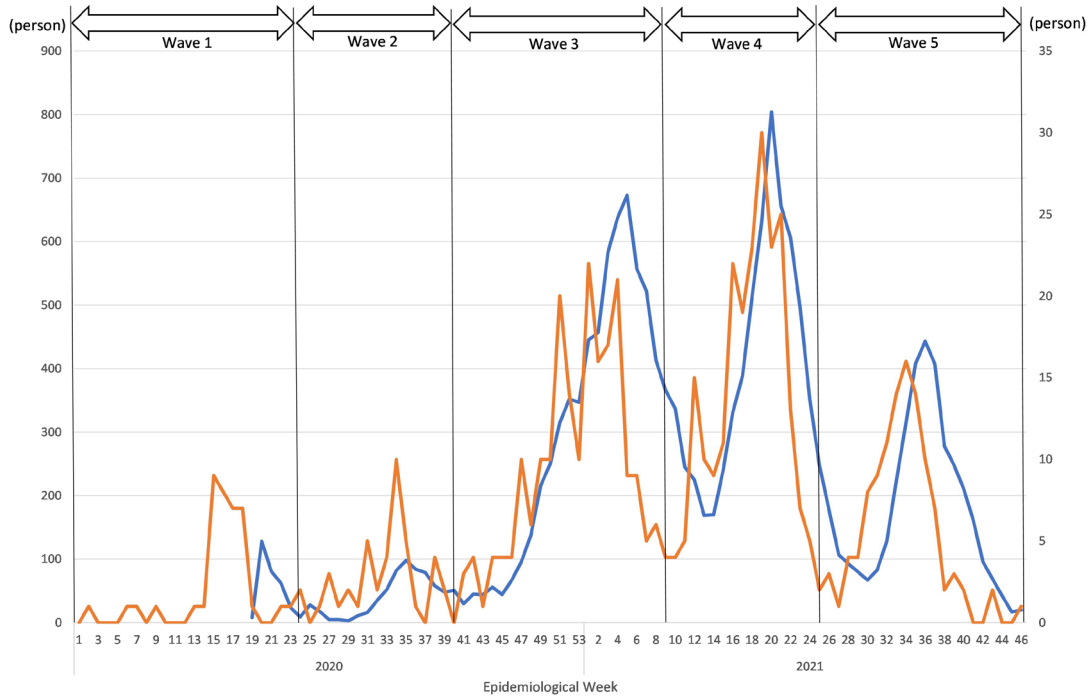

Figure 2. Fatalities with COVID-19 in national data and in MIA data. Notes: The blue line denotes the number of fatalities with COVID-19 in National data (left scale). Orange line denotes the numbers of fatalities by hospitalized week in MIA data (right scale).

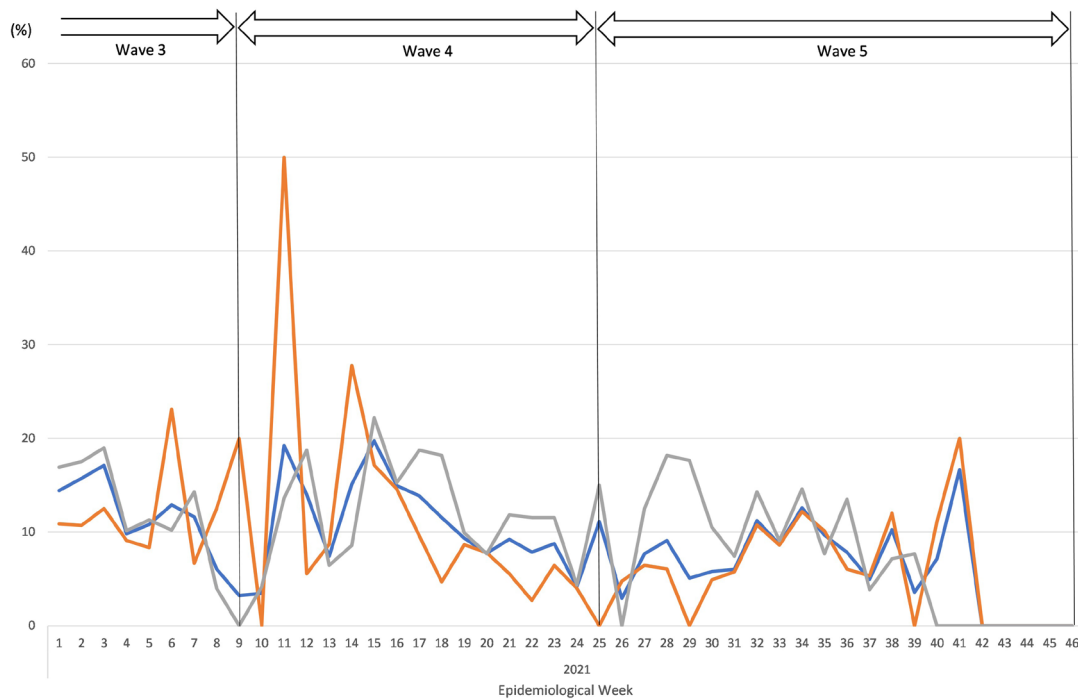

Figure 3. Severity rate among inpatients administered oxygen therapy. Notes: Blue, orange, and gray lines respectively show the severity rate with ventilator use among inpatients with oxygen therapy in the entire population, younger than 65 years old, and 65 years old or older. Severity was defined as the proportion of ventilator use. All data were sourced from MIA data.

coverage for patients 65 years old or older.

Table 1 presents coefficients of determination using proportions of Alpha and Delta variants and vaccination coverage in the hospitalized week, or 1–4 weeks before

hospitalization for all ages and by age classification. The findings indicate the highest coefficients of determination for three weeks before for severity and one week before for fatality for all ages.

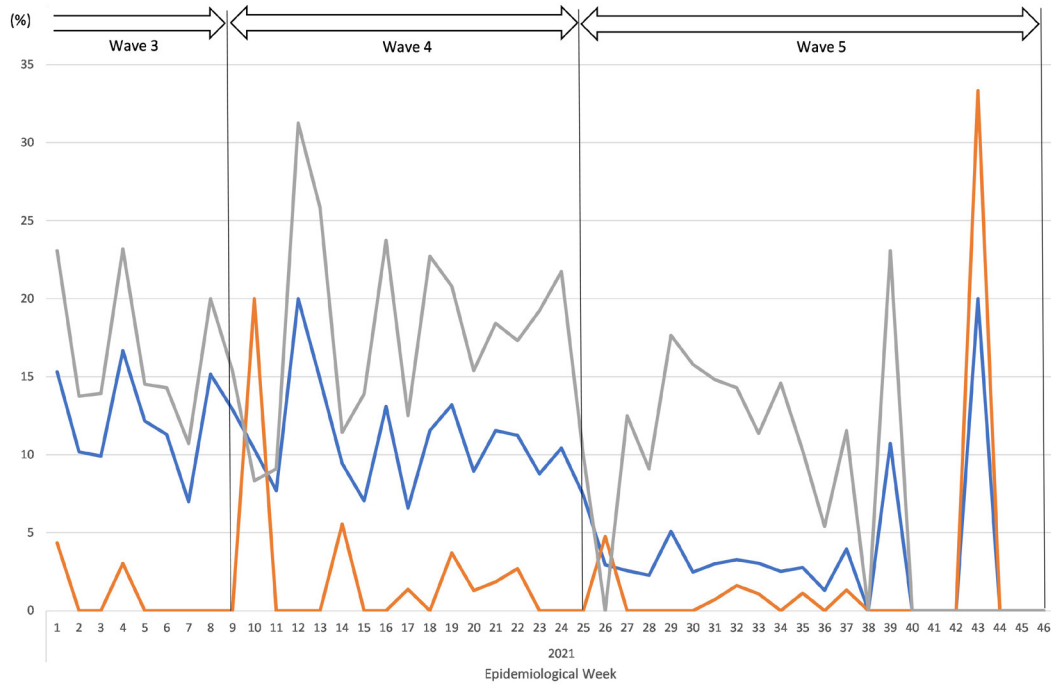

Figure 4. Fatality rate among inpatients administered oxygen therapy. Notes: Blue, orange, and gray lines respectively represent the fatality rate among inpatients with oxygen therapy in the entire population, younger than 65 years old, and 65 years old or older. All data sources were MIA data.

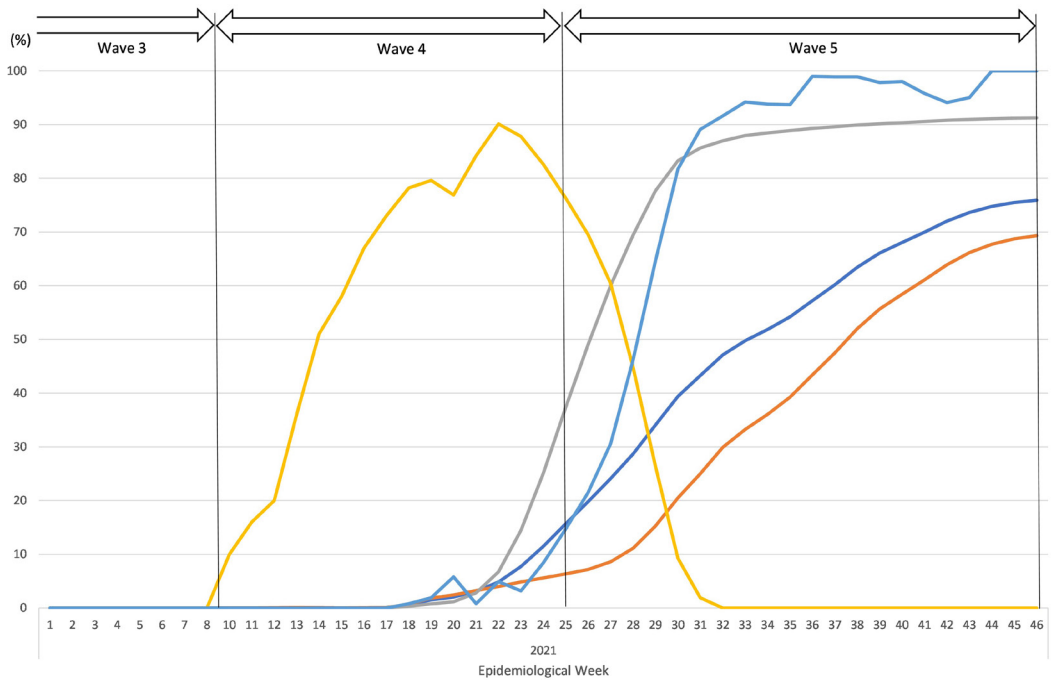

Figure 5. Vaccination coverage with at least one dose in Japan, in addition to proportions of Alpha and Delta variants in Tokyo. Notes: Yellow and light blue lines respectively represent the proportions of the Alpha and Delta variants. Data of the proportions of the Alpha and Delta variants were published by the Cabinet Secretariat. Blue, orange, and gray lines respectively represent vaccination coverage with at least one dose in the entire population, younger than 65 years old, and 65 years old or older. Data of the vaccination coverage were published by the monitoring meeting in Tokyo.

Among inpatients 65 years old or older, the highest coefficients of determination for the severity rate and for the fatality rate were the same: one week. Conversely, among inpatients younger than 65 years old, although the highest coefficients of determination for the fatality rate were the same week with hospitalization, it was six weeks for the severity rate.

Table 2 presents estimation results obtained from multivariable analyses of the association between the severity and fatality rates among inpatients with oxygen therapy and vaccination coverage or Alpha and Delta variant proportions for all ages and by age class. Each estimation result was obtained under the optimal period for each category shown in Table 1. For patients of all ages, at least one dose vaccination and the proportion of Delta variant were found to be associated significantly with the severity rate. Also, the proportion of Alpha variant was associated significantly with the fatality

rate. The results were mixed: the negative sign of the proportion of Alpha variant was unexpected from the hypothesis defined in Method. However, the negative sign of at least one dose vaccination and the positive sign of the proportion of Delta variant were expected. For patients younger than 65 years old, the proportion of the Alpha variant and Delta variant showed negative association with the severity rate significantly, which were unexpected. For all age patients, at least one dose vaccination was negatively associated with the severity and fatality rates. The proportion of Delta variant was positively associated with the severity and fatality rates.

Discussion

All COVID-19 patients, including asymptomatic patients, be admitted mandatory to medical facilities through March 2020. Subsequently, asymptomatic

Table 1. Coefficients of determination obtained using proportions of Alpha and Delta variants and vaccination coverage in the hospitalized week, or 1–4 weeks before hospitalization in all age and by age classification

Length of delay in vaccination coverage and Proportion of Alpha and Delta variants	0	1	2	3	4
All ages with oxygen therapy					
Severity rate	0.33	0.37	0.40	0.43	0.42
Fatality rate	0.17	0.49	0.47	0.47	0.48
Among patients younger than 65 years old					
Severity rate	0.17	0.18	0.23	0.24	0.25
Fatality rate	0.07	0.05	0.06	0.07	0.07
Among patients 65 years old or older					
Severity rate	0.21	0.42	0.40	0.40	0.38
Fatality rate	0.36	0.52	0.51	0.49	0.48

Note: The highest coefficient of determination for the severity rate among inpatients younger than 65 years old with oxygen therapy was 0.2779 when vaccination coverage and the prevalence of the mutated strains were measured six weeks before.

Table 2. Results of multivariate analysis of the association between severity/ fatality and vaccination coverage or proportion of variants among inpatients with oxygen therapy for cases of vaccination coverage two weeks prior and the proportion of Alpha and Delta variants measured several weeks before their hospitalized week determined by Table 1

Variables	Severity Rate		Fatality Rate	
	Estimated coefficient	p value	Estimated coefficient	p value
All ages				
At least one dose vaccination 14 days prior	-0.40	0.00	0.03	0.79
Alpha variant	-0.03	0.10	-0.05	0.04
Delta variant	0.18	0.02	-0.12	0.09
Constant	12.21	0.00	12.57	0.00
Younger than 65 years old				
At least one dose vaccination 14 days prior	1.55	0.07	0.16	0.10
Alpha variant	-0.16	0.00	-0.01	0.73
Delta variant	-0.21	0.01	-0.08	0.14
Constant	14.59	0.000	2.27	0.19
65 years old or older				
At least one dose vaccination 14 days prior	-0.12	0.00	-0.14	0.00
Alpha variant	0.02	0.50	0.00	0.89
Delta variant	0.18	0.01	0.18	0.03
Constant	11.54	0.00	16.69	0.00

Notes: Vaccination coverage and proportions of Alpha and Delta variants were measured three weeks before the hospitalized week for severity rates for all ages. These lags for inpatients younger than 65 years old were zero for severity and six for fatality. For inpatients 65 years old or older, these were one for both dependent variables. The severity rate was defined as the rate of patients who used a respiratory ventilator during their hospital stay among all infected inpatients who were hospitalized the same week. The fatality rate was defined as the rate of inpatients who died among all infected inpatients who were hospitalized the same week. The study period was from week 1 (Wave 1) through week 46, 2021 (Wave 5). The parts highlighted in yellow are significant except for constant terms.

patients or patients with mild symptoms who required no oxygen therapy were admitted optionally based on medical criteria for high risk of exacerbation. They were allowed to stay at home if the number of COVID-19 patients was increasing (20). Furthermore, in cases of an explosive increase, the criteria of hospitalization for asymptomatic patients or patients with mild symptoms who did not require oxygen therapy were probably affected heavily by the scarcity of medical resources or social situations such as support for their staying at home and recuperation at home, aside from pure medical criteria. Under these circumstances, we evaluated the pathogenicity of Alpha and Delta variants and vaccine effectiveness in 2021.

Because the criteria of hospitalization for patients with COVID-19 might have differed for the wave 5, we defined the severity and fatality rates for inpatients with oxygen therapy. From a medical perspective, the criteria for oxygen therapy might be less affected by social situations such as scarcity of medical resources than by criteria for hospitalization. Because the number of inpatients with oxygen therapy was not published in general, we had to use database covering several hospitals and thus covering a sufficient number of inpatients potentially to evaluate of the severity of Alpha and Delta variants and vaccine effectiveness.

As shown in Table 2, the severity and fatality rates for patients 65 years old or older showed negative association with vaccination coverage and positive association with the Delta variant. Findings indicate that vaccination reduced the severity and that the proportion of the Delta variant increased severity, which findings are consistent with those obtained from earlier studies (5-7,18,19).

However, some results were not consistent with those reported from earlier studies. For example, the proportion of the Alpha variant and Delta variant were negatively associated with the severity rate for patients younger than 65 years old. However, no report of the relevant literature has described a study of lower pathogenicity for Alpha and Delta variants.

Some results in severity and fatality were not consistent. This difference might indicate that patients who finally died became more severely ill even in a few weeks than patients who eventually survived, but who received oxygen therapy.

For patients younger than 65 years old, the proportions of Alpha and Delta variant showed significantly negative association with the severity rate, which means that the Alpha and Delta variants had less pathogenicity for patients younger than 65 years old. These results were unexpected. In Table 1, the highest coefficient of determination for severity was six weeks before. It might be too long a period from infection to hospitalization for inpatients with oxygen therapy. Overall, coefficients of determination among younger patients were lower than they were among

older inpatients. In this sense, the estimation for severity among younger inpatients might not be credible. This might be the reason that these results for patients younger than 65 years old were unexpected. Furthermore, one potential reason for the lower pathogenicity of Alpha and Delta variants might be differences of the age distribution of patients with oxygen therapy between waves for which the original strain was dominant and ones for which Alpha and Delta variants were dominant. One potential reason for the lower pathogenicity of Alpha and Delta variants might be differences of age distributions of patients with oxygen therapy among waves dominated by the original or Alpha and Delta variants. The proportion of inpatients younger than 65 years old with oxygen therapy in the wave 3, which was dominated by the original variant, was 28.0%. Their proportion in the wave 4, which was dominated by the Alpha variant, was 43.9%. However, their proportion in the wave 5, which was dominated by the Delta variant, became to be 78.7%. Consequently, the proportion of inpatients younger than 65 years old with oxygen therapy increased. If the severity and fatality rates were lower for patients younger than 65 years old than for patients 65 years old or older, then the results of the Alpha and Delta variants would not be significantly positive for patients of all ages and for patients younger than 65 years old. Whichever might be true, because the results were those of mixed association among Alpha and Delta variants and pathogenicity, more sophisticated analyses using more data must be done to reach a definitive conclusion.

An earlier study investigating the effectiveness of vaccination against Alpha and Delta variants showed that vaccination reduced hospitalizations or deaths. Moreover, its effectiveness for patients 60 years old or older was lower than that for patients younger than 60 years old in test-negative design (19). Another study presented that the case fatality rate was decreasing, and Japan achieved high vaccination rate (21). In our study, the vaccination coverage for all ages and for patients 65 years old or older was found to be significant, as shown in Table 2. These findings might depend on the vaccination strategy pursued in Japan. Vaccination for healthcare workers started on 17 February 2021 (Week 7, 2021, Wave 3). Later, vaccination for patients 65 years old or older started on 12 April 2021 (Week 15, 2021, Wave 4). The proportion of that age group who had at least one vaccination was about 80% by July, as presented in Figure 5. The severity and mortality rates for patients 65 years old or older appears to be declining in Figures 3 and 4, possibly because the starting vaccination was in the same period as the Delta variant emerged, as presented in Figure 5. For all ages, vaccination coverage with at least one vaccination was only 40–50% by late August, when the Delta variant emerged. Vaccination coverage was not associated significantly with severity or fatality for patients younger than 65 years old, probably because vaccination had started for patients 65 years

old or older. Most patients younger than 65 years old were not vaccinated at that time. Results might reflect vaccine effects for patients 65 years old or older. The age distribution of inpatients and of confirmed patients came to reflect more patients younger than 65 years old, for whom the severity and fatality risk were lower than for other patients.

Definition of severity as extracorporeal membrane oxygenation (ECMO) using instead of ventilator using in this study might be possible potentially. However, limitation in capacity of ECMO system in a hospital might be tight especially in the latter study period. If so, severity should be downward biased during capacity of ECMO system was insufficient. Therefore, we avoided the definition of severity by ECMO using.

This study has three limitations. First, as explanatory variables, we considered only the vaccination coverage and the proportions of Alpha and Delta variants. Other factors such as treatment must also be considered. For example, some types of drugs (22) such as remdesivir (23), dexamethasone (24), baricitinib (25), casirivimab/imdevimab (26,27) and sotrovimab (28) were approved for COVID-19 in the study period and more widely administered in the latter period. These drugs may decrease severity and fatality and thus create lower severity and fatality in younger patients during the mutated variants strain dominated. Unfortunately, we cannot use some information of the administered drug in this study. Pathogenicity of the mutated strain and vaccine effectiveness controlled drug administration remained as the next challenge.

Second, although we confirmed the representativeness of fatality cases from MIA data, the exact numbers of patients with oxygen therapy and ventilation in Japan have not been published. Therefore, the representativeness of case severity could not be confirmed.

Third, the only targets of this study were hospitalized patients, for whom "severity rates" and "fatality" might differ from people of the general public. This point must be interpreted carefully because MIA data did not include patients who were not hospitalized.

Even in controlling inpatients' condition as necessary for oxygen therapy, we confirmed that vaccination reduced severity and fatality, and that the Alpha variant and Delta variant might increase severity and fatality among inpatients 65 years old or older, as earlier studies have shown, though such a controlling patients' condition had been never examined.

Acknowledgements

We acknowledge Mr. Masaya Nakadera and Mr. Masato Koizumi, who prepared the database, and thank all hospitals for submitting patient data.

Funding: This work was supported by the Ministry of

Health, Labour, and Welfare (grant number 20HA1005).

Conflict of Interest: The authors have no conflicts of interest to disclose.

References

1. Sawakami T, Karako K, Song P, Sugiura W, Kokudo N. Infectious disease activity during the COVID-19 epidemic in Japan: Lessons learned from prevention and control measures. *Biosci Trends*. 2021; 15:257-261.
2. Karako K, Song P, Chen Y, Karako T. An average of nearly 200,000 new infections per day over a six-week period: What is the impact of such a severe COVID-19 pandemic on the healthcare system in Japan? *Biosci Trends*. 2022; 16:371-373.
3. Karako K, Song P, Chen Y, Tang W, Kokudo N. Overview of the characteristics of and responses to the three waves of COVID-19 in Japan during 2020-2021. *Biosci Trends*. 2021; 15:1-8.
4. Song P, Karako T. The strategy behind Japan's response to COVID-19 from 2020-2021 and future challenges posed by the uncertainty of the Omicron variant in 2022. *Biosci Trends*. 2022; 15:350-352.
5. Ong SWX, Chiew CJ, Ang LW, *et al*. Clinical and virological features of SARS-CoV-2 variants of concern: a retrospective cohort study comparing B.1.1.7 (Alpha), B.1.315 (Beta), and B.1.617.2 (Delta). *Clin Infect Dis*. 2022; 75:e1128-e1136.
6. Twohig KA, Nyberg T, Zaidi A, *et al*. Hospital admission and emergency care attendance risk for SARS-CoV-2 delta (B.1.617.2) compared with alpha (B.1.1.7) variants of concern: A cohort study. *Lancet Infect Dis*. 2022; 22:35-42.
7. Fisman DN, Tuite AR. Evaluation of the relative virulence of novel SARS-CoV-2 variants: A retrospective cohort study in Ontario, Canada. *CMAJ*. 2021; 193:E1619-E1625.
8. Chen Y, Cheng L, Lian R, Song Z, Tian J. COVID-19 vaccine research focusses on safety, efficacy, immunoinformatics, and vaccine production and delivery: A bibliometric analysis based on VOSviewer. *Biosci Trends*. 2021; 15:64-73.
9. Thompson MG, Burgess JL, Naleway AL, *et al*. Prevention and attenuation of Covid-19 with the BNT162b2 and mRNA-1273 vaccines. *N Engl J Med*. 2021; 385:320-329.
10. Ministry of Health, Labour and Welfare of Japan. Survey of medical institutions. <https://www.mhlw.go.jp/toukei/saikin/hw/iryosd/20a/> (Accessed February 10, 2023). (in Japanese)
11. Kanazawa N, Tani T, Imai S, Horiguchi H, Fushimi K, Inoue N. Existing data sources for clinical epidemiology: Database of the national hospital organization in Japan. *Clin Epidemiol*. 2022; 14:689-698.
12. Sato K, Mano T, Niimi Y, Iwata A, Toda T, Iwatsubo T. The impact of COVID-19 pandemic on the utilization of ambulatory care for patients with chronic neurological diseases in Japan: Evaluation of an administrative claims database. *Biosci Trends*. 2021; 15:219-230.
13. NHK WORLD-JAPAN. Tokyo's COVID-19 cases hit all-time high despite state of emergency. <https://www3.nhk.or.jp/nhkworld/en/news/backstories/1725/> (Accessed February 10, 2023).

14. The Japan Times. Japan changed its COVID-19 hospitalization policy: Here's what you need to know. <https://www.japantimes.co.jp/news/2021/08/06/national/suga-covid-19-hospitalization-policy-explainer/> (Accessed February 10, 2023).
 15. Ministry of Health, Labour and Welfare of Japan. Published database on the number of patients diagnosed as COVID-19 2023. <https://www.mhlw.go.jp/stf/covid-19/open-data.html> (Accessed February 10, 2023). (in Japanese)
 16. The Cabinet Secretariat. Vaccination against SARS-CoV-2. <https://www.kantei.go.jp/jp/headline/kansensho/vaccine.html> (Accessed February 10, 2023). (in Japanese)
 17. A monitoring meeting in Tokyo. Conference material, <https://www.bousai.metro.tokyo.lg.jp/taisaku/saigai/1013388/index.html> (Accessed February 10, 2023). (in Japanese)
 18. Chia PY, Ong SWX, Chiew CJ, *et al.* Virological and serological kinetics of SARS-CoV-2 Delta variant vaccine breakthrough infections: A multicentre cohort study. *Clin Microbiol Infect.* 2022; 28:612.e1-612.e7.
 19. Nasreen S, Chung H, He S, *et al.* Effectiveness of COVID-19 vaccines against symptomatic SARS-CoV-2 infection and severe outcomes with variants of concern in Ontario. *Nat Microbiol.* 2022; 7:379-385.
 20. Ministry of Health, Labour and Welfare of Japan. Revision of each measure (surveillance, measures to prevent the spread of infection, medical system) in case of increasing in the number of COVID-19 patients in a region. <https://www.jvnf.or.jp/newinfo/2019/20200301tsuchi.pdf> (Accessed February 10, 2023). (in Japanese)
 21. Karako K, Song P, Chen Y, Karako T. Trends in managing COVID-19 from an emerging infectious disease to a common respiratory infectious disease: What are the subsequent impacts on and new challenges for healthcare systems? *Biosci Trends.* 2022; 16:381-385.
 22. Shao Y, Chen J, Lu H. Update: Drug treatment options for coronavirus disease 2019 (COVID-19). *Biosci Trends.* 2021; 15:345-349.
 23. Mozaffari E, Chandak A, Zhang Z, Liang S, Thrun M, Gottlieb RL, Kuritzkes DR, Sax PE, Wohl DA, Casciano R, Hodgkins P, Haubrich R. Remdesivir treatment in hospitalized patients with coronavirus disease 2019 (COVID-19): A comparative analysis of in-hospital all-cause mortality in a large multicenter observational cohort. *Clin Infect Dis.* 2022; 75:e450-e458.
 24. RECOVERY Collaborative Group; Horby P, Lim WS, *et al.* Dexamethasone in hospitalized patients with Covid-19. *N Engl J Med.* 2021; 384:693-704.
 25. Marconi VC, Ramanan AV, de Bono S, *et al.* Efficacy and safety of baricitinib for the treatment of hospitalised adults with COVID-19 (COV-BARRIER): A randomised, double-blind, parallel-group, placebo-controlled phase 3 trial. *Lancet Respir Med.* 2021; 9:1407-1418.
 26. Su J, Lu H. Opportunities and challenges to the use of neutralizing monoclonal antibody therapies for COVID-19. *Biosci Trends.* 2021; 15:205-210.
 27. Weinreich DM, Sivapalasingam S, Norton T, *et al.* REGEN-COV antibody combination and outcomes in outpatients with Covid-19. *N Engl J Med.* 2021; 385:e81.
 28. Gupta A, Gonzalez-Rojas Y, Juarez E, *et al.* Early treatment for Covid-19 with SARS-CoV-2 neutralizing antibody sotrovimab. *N Engl J Med.* 2021; 385:1941-1950.
-
- Received April 16, 2023; Revised June 12, 2023; Accepted July 13, 2023.
- Released online in J-STAGE as advance publication July 16, 2023.
- *Address correspondence to:*
 Shingo Mitsushima, Center for Field Epidemic Intelligence, Research and Professional Development, National Institute of Infectious Diseases, 1-23-1 Toyama, Shinjuku-ku, Tokyo 162-8640, Japan.
 E-mail: mitsushi@niid.go.jp

Visualization of aerosol spread using a smoke tester during tracheal intubation performed in an operating room

Kohshi Hattori^{1,*}, Asako Eriguchi², Mayuko Omori¹, Osamu Nagata¹

¹Department of Anesthesiology, National Center Hospital of Global Health and Medicine, Tokyo, Japan;

²Department of Dental Anesthesiology, Tokyo Dental College, Tokyo, Japan

Abstract: Tracheal intubation is an essential procedure in the induction of general anesthesia; however, it is also a main source of infectious aerosols such as severe acute respiratory virus 2 (SARS-CoV-2). For protection from infectious aerosols, an air conditioning system which provides continuous laminar air flow from the ceiling and a local isolating device are widely used in typical operating rooms. However, how aerosols spread in an actual operating room has not been visualized, especially during tracheal intubation. In this study, we observed the spread of aerosols under several circumstances. To recreate the scenario of general anesthesia induction, we substituted aerosol spray with smoke from a smoke tester device in the mouth of a human body model placed on the operating table. Then we measured the maximum height of aerosol spread every second for 9 seconds. To verify the contribution of air conditioning and an isolating device, we compared four situations based on their presence or absence. The maximum height of aerosol spread was significantly lower in the presence of laminar air flow from the ceiling. An isolating device contributed to initially enclosing the aerosol; however, some aerosol leaked and diffused depending on the air flow outside the device. During tracheal intubation in typical operating room, air-conditioned laminar air flow can contribute to prevent infectious aerosol spread, and an isolating device can provide supplementary protection.

Keywords: aerosol infection, tracheal intubation, laminar air flow, smoke tester, operating room

Introduction

Tracheal intubation is an essential procedure in general anesthesia; however, it exposes medical staff to infectious aerosols derived from the patient's exhalation, which can be a potential risk of respiratory infections, such as that caused by SARS-CoV-2 (1). Therefore, to protect staff from aerosol infection, it is very important to elucidate how aerosols spread across an operating room.

The most fundamental prevention from infection of coronavirus infectious disease, emerged in 2019 (COVID-19) is hand hygiene (2), however, in some cases such as tracheal intubation, isolation of aerosol is attempted (3). In fact, plenty of cluster cases of COVID-19 infection occurred not only in restaurants but also in medical settings, the main cause of which might be from aerosol droplets. Hence, the most basic characteristics of aerosol infection, in other words, how the actual aerosol spread has not been fully visualized and reported.

Several previous studies have reported simulations with moving images of aerosol spread from coughing patients calculated using supercomputers; however,

these reports were based upon several presuppositions, so the results might not necessarily describe actual aerosol spread and may overlook unexpected factors. In the occupational health field, air flow is commonly checked using a smoke tester, which can provide visible white smoke. This approach can elucidate the general condition of aerosol spread instantly with all surrounding factors considered.

In our central operating department, aerosol infection of COVID-19 has been a great threat (4), because operating room activities cannot be suspended and the room itself can be an epicenter of an infectious outbreak. In a modern operating room, purified laminar air flow is constantly provided from the ceiling to the floor. Additionally, to protect from droplet infection, medical staff undertake standard precautions and occasionally use an isolating device. However, whether such protective gadgets can actually control aerosol spread is not fully understood.

Therefore, we duplicated the scenario of performing tracheal intubation in an air-conditioned operating room with an isolating device, and visualized how exhalation can spread by substituting the aerosol for test smoke.

Materials and Methods

Experiment conditions

We performed this study in the operating room in the Central Operation Center in the Center Hospital of National Center of Global Health and Medicine from July 2020 to February 2021. The cleanliness of the operating room was equivalent to class 2 of healthcare engineering. association of Japan standard-02-2013 (HEAS-02-2013), and air was circulated 15 times per hour with laminar air flow from the ceiling to the floor.

We replicated aerosol release from tracheal intubation as follows; first, we set a human body model (Laerdal® Airway Management Trainer, Lederal, Stavanger, Norway) on the operating table; second, we substituted test smoke for the patient's exhalation during manual ventilation using a smoke tester (Smoke tester kit 500, Gastec Co., Ayase, Kanagawa, Japan), which can provide constant amounts of white smoke (and is usually used for air conditioning management in occupational health); third, we setup an isolating device, shown in Figure 1 (available elsewhere), which was originally used in our hospital. The device was placed between the human body model and a member of the medical staff, so as to cover the patient's face except for two small holes positioned on both sides caudally for arm access to perform tracheal intubation.

We recorded aerosol spread using a high-resolution video camera (RX-100M5A, SONY, Japan) from the left side of the operating table.

Experimental protocol and analysis

We observed the air flow in four different conditions based upon whether air conditioning and an isolating device were provided:

- Condition 1: laminar air flow (+), isolating device (-)
- Condition 2: laminar air flow (-), isolating device (-)
- Condition 3: laminar air flow (+), isolating device (+)
- Condition 4: laminar air flow (-), isolating device (+)

All experiments were performed after the air conditioning system had worked sufficiently or was completely stopped. We sprayed a constant amount of smoke from the right corner of the model's mouth duplicating a patient's exhalation, and recorded, from the side of the operating table, how the smoke spread across the operating room for 9 seconds. Each measurement was performed 5 times per condition. Next, we extracted still images for every second from the recorded moving images and 2 independent

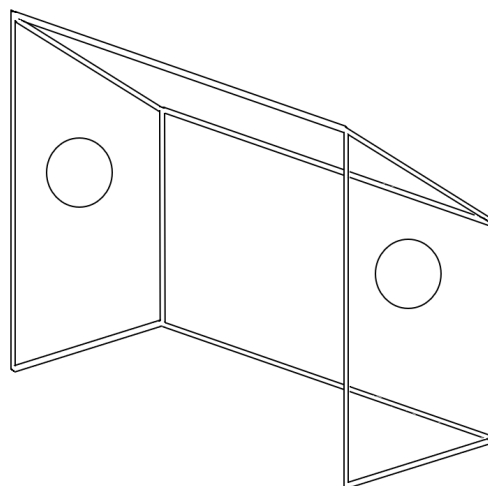

Figure 1. An isolating device originally used in the National Center Hospital of Global Health and Medicine (height, 50 cm × length, 30 cm × width, 45 cm).

reviewers performed evaluations of the maximum height of the smoke with all images randomized to avoid bias based on the conditions and reviewers.

We evaluated the spread of smoke by its maximum height because we especially wanted to monitor how the spread of aerosols can be suppressed by laminar air flow, from the ceiling of the operating room, in conjunction with an isolating device. The obtained data are expressed as average ± standard deviation with one way ANOVA for every condition using the R project for statistical computing.

Results and Discussion

The change over time of the highest point of aerosol diffusion in each condition is shown in Figure 2 and Table 1. The characteristic diffusion of aerosol in each condition is shown in Figure 3.

The presence of laminar air flow significantly contributed to suppress the diffusion of aerosol throughout the experiment. In addition, under laminar air flow circumstances, no additional effect was observed regardless of the presence of the isolation device. On the other hand, without laminar air flow, the isolation device significantly suppressed the diffusion of aerosol at first, however, over time, the aerosols leaked outside the device and diffused.

We visualized the distribution of aerosol in an operating room effectively and conveniently using our test smoke model. It strongly suggests that continuous laminar air flow from the ceiling plays a major role in the evacuation of aerosol.

In contrast, use of an isolating device provided mixed effects. It completely enclosed the aerosol derived from the cough reflex at an early phase regardless of the presence of laminar air flow. However, the leaked aerosol diffused depending on the presence

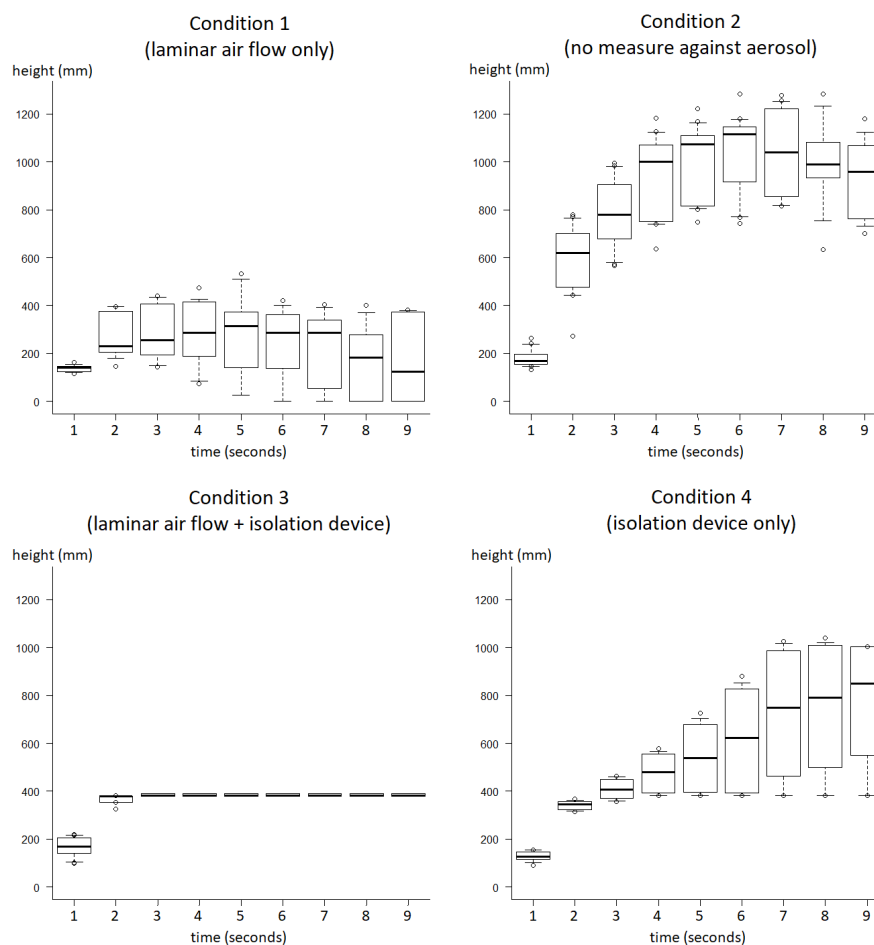

Figure 2. Distribution of aerosol in each condition. Condition 1: laminar air flow (+), isolating device (-); Condition 2: laminar air flow (-), isolating device (-); Condition 3: laminar air flow (+), isolating device (+); Condition 4: laminar air flow (-), isolating device (+).

of air flow outside the device, and by contrast, contaminated aerosol inside the device was trapped for a long time.

The risk of aerosol infection is widely known from previous studies (4). However, with the use of visualized smoke, our study shows that there is no exhaust route for the isolated aerosols, which leak from the edge of the isolating box at the very early stage of inhalation.

These findings suggest that an air-conditioned operating room is suitable for infection-safe tracheal intubation, with recommended addition of an isolating device in the case of a risk of convulsive exhalation, such as during a cough reflex and mask ventilation. Tracheal intubation performed without an air conditioning system or solely using an isolating device might place medical staff at potential risk of exposure to patient-derived aerosols.

In our study, we used a smoke tester, which is widely used in industrial hygiene departments, to visualize aerosol spread from a patient. The smoke tester can provide a constant amount of smoke

containing particles with similar size and characteristics to exhaled aerosols. Moreover, it has excellent visual recognizability and low toxicity. Thus, this smoke tester model is suitable for visually evaluating the distribution of aerosols in other areas outside of the operating room.

The effectiveness of air conditioning in the operating room depends on several factors, including the size of the room and arrangement of equipment for surgery, which might unexpectedly interrupt air conditioning. Therefore, this practical air flow simulation system may contribute to preventing aerosol-based infection at clinical sites. Conversely, an isolation device blocked laminar air flow completely on the patient, resulting in aerosol drifting in the isolated area during measurement. This result suggests that we should pay special attention to aerosol infection "inside" the isolated area and "recurrence" of aerosol diffusion when removing the device. Nevertheless, isolating devices can be effective in suppressing the early phase of aerosol diffusion derived from aerosol spouting, such as that due to the cough reflex; however, our result showed that for subsequent control of aerosol

Table 1. Qualitative description and maximum height of aerosol spread in conditions 1 to 4

Seconds	1	2	3	4	5	6	7	8	9
Average ± SD (Condition 1)	138.7 ± 14.9	273.9 ± 96.6	290.1 ± 118.9	283.9 ± 140.5	277.4 ± 181.7	236.2 ± 156.2	213.6 ± 162.4	162.4 ± 156.8	167.7 ± 172.7
Average ± SD (Condition 2)	181.0 ± 39.0	591.9 ± 151.3	787.0 ± 146.9	940.6 ± 177.1	1003.5 ± 162.8	1044.0 ± 177.7	1046.0 ± 183.7	992.6 ± 188.2	938.0 ± 184.4
Average ± SD (Condition 3)	165.9 ± 41.7	368.2 ± 17.3	383.7 ± 5.48	383.7 ± 5.5	383.7 ± 5.5	383.7 ± 5.5	383.7 ± 5.5	383.7 ± 5.5	384.2 ± 5.9
Average ± SD (Condition 4)	128.1 ± 21.8	341.5 ± 20.1	408.9 ± 44.0	476.3 ± 86.8	542.1 ± 156.4	618.0 ± 234.6	725.3 ± 288.1	751.6 ± 283.2	773.9 ± 271.2
<i>p</i> value (ANOVA)	0.0031	<0.001	<0.001	<0.001	<0.001	<0.001	<0.001	<0.001	<0.001
<i>p</i> value (Bonferroni test)									
Condition 1 vs. 2 (air-condition on/off without isolation device)	0.029	<0.001	<0.001	<0.001	<0.001	<0.001	<0.001	<0.001	<0.001
Condition 1 vs. 3 (isolation device on/off with air-condition)	0.367	0.15	0.208	0.396	0.524	0.215	0.184	0.033	0.163
Condition 1 vs. 4 (air-condition vs isolation device)	1	0.85	0.099	0.013	0.002	<0.001	<0.001	<0.001	<0.001
Condition 2 vs. 3 (both on/off)	1	<0.001	<0.001	<0.001	<0.001	<0.001	<0.001	<0.001	<0.001
Condition 2 vs. 4 (isolation device on/off without air-condition)	0.007	<0.001	<0.001	<0.001	<0.001	<0.001	0.002	0.032	0.611
Condition 3 vs. 4 (air-condition on/off with isolation device)	0.098	1	1	0.646	0.113	0.015	<0.001	<0.001	<0.001

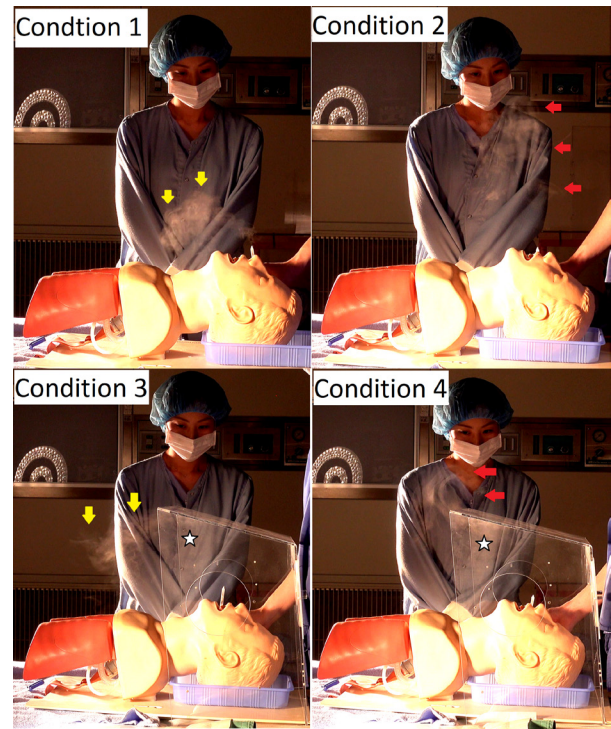

Figure 3. Characteristic diffusion of aerosol in each condition. Condition 1: laminar air flow (+), isolating device (-); Condition 2: laminar air flow (-), isolating device (-); Condition 3: laminar air flow (+), isolating device (+); Condition 4: laminar air flow (-), isolating device (+). The aerosol is confined by laminar air flow (yellow arrows), and diffuses without the presence of laminar air flow (red arrows). Inside the isolated area, the aerosol drifts with/without the presence of laminar air flow (white stars).

diffusion, laminar air flow is an essential factor and the role of the isolating device remains limited.

Computer simulation is another effective method of elucidating aerosol behavior. It has superior reproducibility and can provide quantitative evaluations. However, these simulations require a supercomputer, the availability of which is often limited. Additionally, it also requires all preconditions to be converted to numerical parameters, some of which might not be quantized properly or remain unintentionally overlooked. By contrast, observing air flow using a smoker tester is relatively easy and inexpensive, which can help manage prevention of aerosol-based infection.

In conclusion, our smoke tester model is a simple and practical tool for visualizing actual air flow in an operating room with a potential risk of aerosol infection. Based upon our results, we recommend that infection-safe tracheal intubation should be performed in facilities with a laminar air flow system installed, such as in an operating room.

Funding: This study was funded by Japan Society for the Promotion of Science (JP20K17776).

Conflict of Interest: The authors have no conflicts of interest to disclose.

References

1. Sommerstein R, Fux C, Vuichard-Gysin D, Abbas M, Marschall J, Balmelli C, Troillet N, Harbarth S, Schlegel M, Widmer A; Swissnos. Risk of SARS-CoV-2 transmission by aerosols, the rational use of masks, and protection of healthcare workers from COVID-19. *Antimicrob Resist Infect Control*. 2020; 9:100.
 2. Rundle CW, Presley CL, Militello M, Barber C, Powell DL, Jacob SE, Atwater AR, Watsky KL, Yu J, Dunnick CA. Hand hygiene during COVID-19: Recommendations from the American Contact Dermatitis Society. *J Am Acad Dermatol*. 2020; 83:1730-1737.
 3. Tang S, Mao Y, Jones RM, Tan Q, Ji JS, Li N, Shen J, Lv Y, Pan L, Ding P, Wang X, Wang Y, MacIntyre CR, Shi X. Aerosol transmission of SARS-CoV-2? Evidence, prevention and control. *Environ Int*. 2020; 144:106039.
 4. Dexter F, Parra MC, Brown JR, Loftus RW. Perioperative COVID-19 defense: An evidence-based approach for optimization of infection control and operating room management. *Anesth Analg*. 2020; 131:37-42.
-
- Received July 31, 2022; Revised October 30, 2022; Accepted November 13, 2022.
- Released online in J-STAGE as advance publication November 28, 2022.
- *Address correspondence to:*
Kohshi Hattori, Department of Anesthesiology, National Center Hospital of Global Health and Medicine, 1-21-1 Toyama, Shinjuku-ku, Tokyo 162-8655, Japan.
E-mail: khatsutori-ky@umin.org

Clinical features of cervical cancer at a national cancer center in Phnom Penh, Cambodia: A descriptive cross-sectional study

Aya Tanaka¹, Linka Koun², Rei Haruyama^{1*}, Kyna Uy², Maryan Chhit², Lumpiny Kim², Noriko Fujita¹, Yutaka Osuga³, Tadashi Kimura⁴, Kanal Koum⁵

¹Bureau of International Health Cooperation, National Center for Global Health and Medicine, Tokyo, Japan;

²Department of Obstetrics and Gynecology, Khmer-Soviet Friendship Hospital, Phnom Penh, Cambodia;

³Department of Obstetrics and Gynecology, Faculty of Medicine, The University of Tokyo, Tokyo, Japan;

⁴Department of Obstetrics and Gynecology, Osaka University Graduate School of Medicine, Osaka, Japan;

⁵Cambodian Society of Gynecology and Obstetrics, Phnom Penh, Cambodia.

Abstract: The clinical features of newly diagnosed cervical cancer in Cambodia are poorly documented. We aimed to describe the histologic type and stage distributions of newly diagnosed cervical cancer patients at the Khmer Soviet Friendship Hospital in Phnom Penh, which is one of the two national cancer centers in Cambodia. A descriptive cross-sectional study was conducted using the Gynecologic Test Registry of the gynecology department between January and December 2019. In 2019, 351 women were histologically diagnosed with cervical cancer, representing approximately one-third of the estimated total cases occurring in the country. The mean age at presentation was 54.7 years. The histologic type distribution was largely consistent with other Asian countries, with squamous cell carcinoma accounting for 83.8%, followed by adenocarcinoma (15.4%). Among 309 patients with recorded staging information, 57.6% were advanced-stage cancers (*i.e.* stage IIB or higher). Raising awareness of early symptoms of cervical cancer, increasing access to cancer diagnosis, and better recording of patients' clinical information are important to improve cervical cancer management in Cambodia.

Keywords: uterine cervical neoplasms, delayed diagnosis, neoplasms by histologic type, Cambodia

Introduction

Cervical cancer is caused by persistent infection with oncogenic human papillomavirus (HPV), which progresses slowly from precancerous lesions to invasive carcinoma (1). If detected at an early stage of progression, it is more likely treatable with good survival prognosis (2). However, in countries without effective cervical cancer screening and early diagnosis programs, patients are often diagnosed as advanced-stage cancer with high mortality.

In Cambodia, cervical cancer is one of the leading cancers in women with an estimated 1,100 new cases and 600 deaths in 2020 (3). These numbers correspond to an age-standardized incidence rate of 14.0 per 100,000 and mortality rate of 8.3 per 100,000, both of which are higher than global estimates. The Cambodian Ministry of Health has placed cervical cancer as one of its priorities for non-communicable disease agenda, and vaginal inspection-based screening is offered to women in some health centers and hospitals (4). However, the screening test is not yet freely available and widely

recognized by many women. In a 2016 population-based survey, the percentage of women aged 18–69 years who have ever had cervical cancer screening was only 11.3% (5). Often, women visit health facilities only when they have recurring symptoms of abnormal vaginal bleeding. The exact number of women affected with the cancer and their clinical features, including stage at diagnosis, remain unknown due to a lack of cancer registration system. Previous studies on cervical cancer in Cambodia are limited to those on cancer awareness and the prevalence of HPV and cervical dysplasia (6-9).

The Khmer-Soviet Friendship Hospital (KSFH) is a national cancer center located in Phnom Penh, the capital city of Cambodia. It is one of four public hospitals with pathology services and one of two with cancer treatment capacity. Women suspected of having cervical cancer are referred to a gynecology department across the country. In this study, we aimed to describe the histologic type and stage distributions of newly diagnosed cervical cancer patients presenting at the KSFH.

Materials and Methods

Study design and sample

This descriptive cross-sectional study was conducted using the Gynecologic Test Registry of the gynecology out-patient department of the KSFH between January and December 2019, before the COVID-19 pandemic. This registry compiled information on patients who underwent gynecological tests, such as cytology, colposcopy, and biopsy. In addition to patient name, identification number, age, parity, place of residence, and type of test received, the registry also included test results, clinical diagnosis, and stage at diagnosis for malignant cases. For cervical cancer patients, staging was recorded using the 2009 International Federation of Gynecology and Obstetrics (FIGO) staging system (10). We extracted data of histologically confirmed cervical cancer patients for this study.

Data analysis

Descriptive statistics were performed to examine the sociodemographic and clinical characteristics of the study participants. As in previous studies, we defined FIGO stage IA to IIA patients as early-stage cancer, and FIGO stage IIB or higher as advanced-stage cancer (11-14). At the KSFH, early-stage cancers are usually operated surgically with or without adjuvant external beam radiotherapy and chemotherapy (brachytherapy is being planned for installation, but not yet available). Excluding cases with missing staging information, univariate logistic regression analysis was performed to examine factors associated with advanced-stage presentation. Data analysis was performed using Stata/SE 16.1 (Stata Corporation, College Station, TX, USA). Statistical significance was set at $p \leq 0.05$. Ethical approval was obtained from the Cambodia National Ethics Committee for Health (312 NECHR) and Ethics Committee of the National Center for Global Health and Medicine in Japan (NCGM-G-004021-00). Since the study used an existing database, informed consent was substituted by making research information widely available and ensuring that women had the opportunity to opt out of the study.

Results and Discussion

A total of 351 histologically confirmed cervical cancer patients were analyzed in this study (Table 1). The mean age at presentation was 54.7 ± 9.6 years, ranging between 30–81 years. Women presented from across the country, with 28.8% from Phnom Penh or Kandal (*i.e.*, a province surrounding Phnom Penh), 35.9% from the five adjacent provinces of Kandal, and the remaining 17 distant provinces located over 3–10 h drive to Phnom Penh. All the patients underwent

Table 1. Sociodemographic and clinical characteristics of the study sample

Characteristics	n (%)
Total	351
Age, years	
Mean	54.7 ± 9.6
30–39	20 (5.7)
40–49	77 (21.9)
50–59	148 (42.2)
60–69	80 (22.8)
≥ 70	26 (7.4)
Parity	
0	30 (8.6)
0–3	136 (38.8)
≥ 4	181 (51.6)
Not reported	4 (1.1)
Place of residence	
Phnom Penh or Kandal	101 (28.8)
Adjacent province of Kandal [†]	126 (35.9)
Distant province	124 (35.3)
Histopathology result of cervical biopsy	
Squamous cell carcinoma	294 (83.8)
Adenocarcinoma	54 (15.4)
Small cell carcinoma	2 (0.6)
Undifferentiated carcinoma	1 (0.3)
Stage at diagnosis	
I	
IA	2 (0.6)
IB	48 (13.7)
II	
IIA	81 (23.1)
IIB	78 (22.2)
Unknown subclassification	1 (0.3)
III	
IIIA	38 (10.8)
IIIB	44 (12.5)
Unknown subclassification	6 (1.7)
IV	
IVA	3 (0.9)
IVB	1 (0.3)
Unknown subclassification	7 (2.0)
Unknown stage	42 (12.0)

[†]Prey Veng, Kampong Cham, Kampong Chhnang, Kampong Speu, or Takeo

cervical biopsy, and pathological results were recorded. Squamous cell carcinoma (SCC) accounted for 83.8% of the cases, followed by adenocarcinoma (15.4%), small cell carcinoma (0.6%), and undifferentiated carcinoma (0.3%). Staging information was recorded for 309 patients (88.0%). Among them, 57.6% were advanced-stage cancers (Table 2). The proportions of advanced-stage cancer were high in women who were aged 30–39 years (68.4%), over 70 years (65.2%), had 1–3 children (61.2%), or lived in adjacent provinces of Kandal (61.4%); however, no statistically significant association was observed.

This study examined the histologic type and stage distributions of newly diagnosed cervical cancer patients that presented to the KSFH in 2019. Although this was a single-center analysis, it is the first to describe the clinical features of cervical cancer at a national cancer center in Cambodia. Overall, there were 351 patients, representing approximately one-third of the estimated total cases occurring in the country (3). Cervical cancer was more commonly diagnosed among

Table 2. Advanced-stage presentation and its associated factors

Characteristics	Advanced-stage presentation		Crude odds ratio (95% CI)	p value
	Yes n (%)	No n (%)		
Total	178 (57.6)	131 (42.4)		
Age				
30–39	13 (68.4)	6 (31.6)	1.5 (0.5–4.1)	0.5
40–49	40 (58.8)	28 (41.2)	1.0 (0.5–1.8)	0.9
50–59	78 (59.5)	53 (40.5)	1	NA
60–69	32 (47.1)	36 (52.9)	0.6 (0.3–1.1)	0.1
≥ 70	15 (65.2)	8 (34.8)	1.3 (0.5–3.2)	0.6
Parity				
0	12 (44.4)	15 (55.6)	1	NA
1–3	74 (61.2)	47 (38.8)	2.0 (0.8–4.6)	0.1
≥ 4	90 (57.0)	68 (43.0)	1.7 (0.7–3.8)	0.2
Not reported	2 (66.7)	1 (33.3)	2.5 (0.2–31.0)	0.5
Place of residence				
Phnom Penh or Kandal	51 (58.0)	37 (42.0)	1	NA
Adjacent province of Kandal [†]	70 (61.4)	44 (38.6)	1.2 (0.7–2.0)	0.6
Distant province	57 (53.3)	50 (46.7)	0.8 (0.5–1.5)	0.5
Histologic type				
Squamous cell carcinoma	150 (58.4)	107 (41.6)	1	NA
Non-squamous cell carcinoma	28 (53.9)	24 (46.1)	0.8 (0.5–1.5)	0.5

[†]Prey Veng, Kampong Cham, Kampong Chhnang, Kampong Speu, or Takeo. CI: confidence interval

women in their 50s. Histologically, SCC accounted for 83.8% of the cases, followed by adenocarcinoma (15.4%). Among patients with recorded staging information, 57.6% were in their advanced stage (*i.e.*, stage IIB or higher).

Cervical biopsy and pathological examination are necessary to establish a definitive diagnosis of cancer and identify the histologic type (15). This analysis confirmed that all suspected and clinically diagnosed cervical cancer patients underwent biopsy at the KSFH. The proportion of SCC was largely consistent with studies from Thailand (71.1%), China (74.5%), and Japan (72.6%) (16–18).

The proportion of advanced-stage cancer (*i.e.*, stage IIB or higher) was unexpectedly lower than that in studies conducted in similar settings of lower-middle income countries. The advanced-stage cervical cancer presentation was reported to be 64% of 202 patients at a referral hospital in Tanzania, 78% of 246 at a regional cancer center in India, and 81% of 110 at two referral hospitals in Nepal (11,13,14). This may be due to successful early referrals of suspected cervical cancer patients from district hospitals and non-governmental organization clinics to the KSFH. However, this may also be because many of the patients we excluded due to missing information on staging (12% of 351 patients) may be advanced-stage cancers. The KSFH is a public hospital that serves many patients with low socioeconomic status, and some women refuse to get tested and treated due to fear of procedures and high healthcare costs. Pelvic examination, transvaginal ultrasound, and renal ultrasound are usually performed; however, computed tomography and magnetic resonance imaging are rare (< 10%), thereby limiting the evaluation of lymph nodes, local extension, and systemic spread.

A systematic review of 25 studies examining the determinants of advanced-stage presentation found that women with no formal education and those residing in rural areas were significantly more likely to present in the advanced stage than their counterparts (19). However, in our study, these factors showed no association. Lack of association with place of residence was contrary to our expectation, because public hospitals with pathology laboratories are only located in Phnom Penh and patients have to visit one of these hospitals themselves, including the KSFH, for a biopsy and pathological examination. An explanation may be that women suspected of having advanced-stage cervical cancer but living in rural provinces may be unable to reach the KSFH for definitive diagnosis and treatment. In contrast, women suspected of having early-stage cervical cancer and living in Phnom Penh and Kandal may visit other hospitals from the outset, including those in neighboring countries, such as Thailand, Singapore, and Vietnam.

This study utilized a clinical registry introduced through a cervical cancer prevention and control project by professional societies in Cambodia and Japan (20). It contained minimum possible information of all patients receiving gynecologic tests at the KSFH. Although we examined the clinical features of newly diagnosed cervical cancer patients presenting at a national cancer center for the first time, there are several limitations. First, data on patients' education, occupation, household income, comorbidity, and history of screening were not available in the registry, and we could not fully examine the baseline characteristics of the patients, as well as the adjusted effect of these factors on advanced-stage presentation. Second, we were unable to identify whether the patients underwent any treatment because this information was not included in the registry,

and individual medical records do not exist at the gynecology department of KSFH. We attempted to go through the surgical records and pathology results of surgical specimens for early-stage patients, but we found that personal identification numbers are often incorrectly recorded, or two or more numbers exist for one person. It was also difficult to identify patients who underwent radiotherapy or chemotherapy at the oncology department or those who were referred elsewhere. It is critical to improve the recording of each patient's clinical information to better understand the current situation in the management of cervical cancer and formulate strategies to reduce preventable deaths. This will become even more important with the government's recent move to scale-up cervical cancer screening, as screen-detected invasive cancer will surely increase in previously unscreened large populations (2,21).

In conclusion, our study showed that over half of women presented at an advanced stage. Raising awareness of early symptoms of cervical cancer, increasing access to cancer diagnosis, and better recording of patients' clinical information are important to improve cervical cancer management in Cambodia.

Funding: This work was supported by Japan International Cooperation Agency Partnership Program, by National Center for Global Health and Medicine Intramural Research Fund (20A08), and by Health Labour Sciences Research Grant (23EA3201).

Conflict of Interest: The authors have no conflicts of interest to disclose.

References

- Schiffman M, Castle PE, Jeronimo J, Rodriguez AC, Wacholder S. Human papillomavirus and cervical cancer. *Lancet*. 2007; 370:890-907.
- World Health Organization. WHO Framework for strengthening and scaling-up of services for the management of invasive cervical cancer. <https://www.who.int/publications/i/item/9789240003231> (accessed January 20, 2023)
- International Agency for Research on Cancer, Global Cancer Observatory: Cancer Today. 2020. <https://gco.iarc.fr/today/> (accessed June 6, 2023).
- Ministry of Health Cambodia. National Strategic Plan for the Prevention and Control of Noncommunicable Diseases 2022-2030, Ministry of Health Cambodia, Phnom Penh, Cambodia, 2022; pp.18-39.
- University of Health Sciences Cambodia, Ministry of Health Cambodia. Prevalence of Non-Communicable Diseases Risk Factors in Cambodia (STEPS survey 2016). Ministry of Health Cambodia, Phnom Penh, Cambodia, 2016; pp.81-82.
- Touch S, Oh JK. Knowledge, attitudes, and practices toward cervical cancer prevention among women in Kampong Speu Province, Cambodia. *BMC Cancer*. 2018; 18:294.
- Soeung SC, Komagata T, Darapheack C, Kikuchi S, Obara H, Haruyama R, Kanal K, Fujita N, Yanaihara N, Okamoto A, Kumura T. Knowledge and practice for cervical cancer among female primary school teachers in Phnom Penh, Cambodia: A cross-sectional phone-based survey. *GHM Open*. 2022; 2:25-30.
- Ueda Y, Kawana K, Yanaihara N, *et al*. Development and evaluation of a cervical cancer screening system in Cambodia: A collaborative project of the Cambodian Society of Gynecology and Obstetrics and Japan Society of Obstetrics and Gynecology. *J Obstet Gynaecol Res*. 2019; 45:1260-1267.
- Thay S, Peprah SA, Hur C, Tramontano AC, Maling E, Goldstein AT, Hong C. Prevalence of cervical dysplasia in HIV-positive and HIV-negative women at the Sihanouk Hospital Center of HOPE, Phnom Penh, Cambodia. *Asian Pac J Cancer Prev*. 2019; 20:653-659.
- Pecorelli S. Revised FIGO staging for carcinoma of the vulva, cervix, and endometrium. *Int J Gynaecol Obstet*. 2009; 105:103-104.
- Mlange R, Matovelo D, Rambau P, Kidenya B. Patient and disease characteristics associated with late tumour stage at presentation of cervical cancer in northwestern Tanzania. *BMC Womens Health*. 2016; 16:5.
- Dunyo P, Effah K, Udofia EA. Factors associated with late presentation of cervical cancer cases at a district hospital: A retrospective study. *BMC Public Health*. 2018; 18:1156.
- Gyenwali D, Pariyar J, Onta SR. Factors associated with late diagnosis of cervical cancer in Nepal. *Asian Pac J Cancer Prev*. 2013; 14:4373-4377.
- Senapati R NB, Kar S K, Dwibedi B. Why cervical cancer cases are being lately diagnosed in Eastern India? An analysis of the associated factors. *Indian Journal of Obstetrics and Gynecology Research*. 2016; 3:418-421.
- Bhatla N, Aoki D, Sharma DN, Sankaranarayanan R. Cancer of the cervix uteri: 2021 update. *Int J Gynaecol Obstet*. 2021; 155 Suppl 1:28-44.
- Rudtanajudjatam K, Charoenkwan K, Khunamornpong S, Siriaunkgul S. Impact of histology on prognosis of patients with early-stage cervical cancer treated with radical surgery. *Int J Gynaecol Obstet*. 2011; 115:183-187.
- Meng Y, Chu T, Lin S, Wu P, Zhi W, Peng T, Ding W, Luo D, Wu P. Clinicopathological characteristics and prognosis of cervical cancer with different histological types: A population-based cohort study. *Gynecol Oncol*. 2021; 163:545-551.
- Nagase S, Ohta T, Takahashi F, Yamagami W, Yaegashi N, Board Members of the 2020 Committee on Gynecologic Oncology of the Japan Society of Obstetrics and Gynecology. Annual report of the Committee on Gynecologic Oncology, the Japan Society of Obstetrics and Gynecology: Annual Patient Report for 2018 and Annual Treatment Report for 2013. *J Obstet Gynaecol Res*. 2022; 48:541-552.
- Tekalign T, Teshome M. Prevalence and determinants of late-stage presentation among cervical cancer patients, a systematic review and meta-analysis. *PLoS One*. 2022; 17:e0267571.
- Kanal K, Fujita N, Soeung SC, Sim KL, Matsumoto Y, Haruyama R, Banno K, Kimura T. The cooperation between professional societies contributes to the capacity building and system development for prevention and control of cancer in low- and middle-income countries:

- the practice of Cervical Cancer Prevention and Control Project in Cambodia. *Glob Health Med.* 2020; 2:48-52.
21. Elit L, Haruyama R, Gatti A, Howard SC, Lam CG, Fidarova E, Angioli R, Cao X, Trapani D, Ilbawi A. Examining policy cohesion for cervical cancer worldwide: Analysis of WHO country reports. *ESMO Open.* 2020; 5:e000878.

14, 2023.

Released online in J-STAGE as advance publication June 18, 2023.

**Address correspondence to:*

Rei Haruyama, Bureau of International Health Cooperation, National Center for Global Health and Medicine, 1-21-1 Toyama, Shinjuku-ku, Tokyo 162-8655, Japan.
E-mail: rharuyama@it.ncgm.go.jp

Received April 6, 2023; Revised June 9, 2023; Accepted June

Psychodynamic therapy for adverse childhood experience in a hospitalized girl with attention deficit hyperactivity disorder

Kaori Sugimoto¹, Toshinari Kurokouchi¹, Rena Shinohara¹, Yuuki Sakoh¹, Maiko Odaka¹, Hikaru Sunakawa², Shuichi Tanese³, Manao Seto¹, Masahiro Ishida^{1,4}, Yuta Yoshimura⁵, Kotoe Itagaki⁶, Ikuhiro Harada⁴, Saori Inoue^{1,7}, Yuki Hakoshima¹, Kumi Inazaki¹, Yuki Mizumoto^{1,8}, Masahide Usami^{1,8,*}

¹ Department of Child and Adolescent Psychiatry, Kohnodai Hospital, National Center for Global Health and Medicine, Ichikawa, Japan;

² Department of Pediatrics, Shimoshizu Hospital, Chiba, Japan;

³ Matsudo city Child Development Center, Matsudo, Japan;

⁴ Department of Social Work, Kohnodai Hospital, National Center for Global Health and Medicine, Ichikawa, Japan;

⁵ Department of Psychiatry, Department of Psychiatry, Faculty of Medicine, Fukuoka University, Fukuoka, Japan;

⁶ Department of Clinical Psychology, Kohnodai Hospital, National Center for Global Health and Medicine, Ichikawa, Japan;

⁷ Department of Neuropsychiatry, Ehime University Graduate School of Medicine, Toon City, Japan;

⁸ Clinical Center for Children's Mental Health, Kohnodai Hospital, National Center for Global Health and Medicine, Ichikawa, Japan.

Abstract: Child abuse and neurodevelopmental disorders are serious social issues in Japan. Abused children may present with symptoms similar to attention deficit/hyperactivity disorder (ADHD), such as increased impulsivity and difficulty concentrating. It is also known that children with ADHD are more likely to suffer from maltreatment, which can lead to psychiatric symptoms such as low self-esteem, depression, and defiant, challenging attitudes. Child psychiatric treatment needs to take both perspectives, childhood adversity and neurodevelopmental disorders, into account. In this case (A), there was a history of impulsive challenging behavior; in addition to the ADHD symptoms, the abusive upbringing from an early age had resulted in increased aggression, psychological damage, and low self-esteem. The abusive mother was also a competitor to her and was vulnerable and unable to present a healthy femininity to her. She entered adolescence without sufficient support from her mother before puberty. The ambivalence of dependence and rebellion extremely increased, and the problem manifested as withdrawal. In the treatment, while setting limits, positive evaluations of the positive aspects were actively communicated. Her therapist was particularly aware of becoming a part of her ego function different from her mother. A's challenging behavior was gradually reduced, and she was able to develop the right self-image. This is a case in which the structure of the hospitalization enabled the work of limiting the patient while protecting and accepting her. Clinical serious issues such as withdrawal, defiant challenging behavior, and symptoms of hyperactive impulsive inattention in adolescents require consideration and response to background adversity experiences and child abuse factors.

Keywords: inpatient, child, child abuse, ADHD

Introduction

In Japan, several social issues exist, including the lack of child psychiatrists and child psychiatric wards as well as the rapid increase in the prevalence of child abuse. The prevalence of attention deficit/hyperactivity disorder (ADHD), which is one of the most common neurodevelopmental disorders, as well as autism spectrum disorders, is estimated to be 7.2% (1). Individuals with ADHD exhibit hyperactivity, impulsivity, and inattention. Furthermore, this condition is complex and involves a combination of biological and psychosocial factors, *e.g.*, increased impulsivity and irritability due to attachment difficulties and possible

mood disorders, such as severe emotional dysregulation (2,3). Close attention should be paid to environmental factors (*e.g.*, bullying, teacher reprimands, parental abuse) that may influence the symptoms of ADHD. For example, of the 878 patients prescribed the three anti-ADHD medications Methylphenidate, Atomoxetine, and Ganfacine, 43 (4.9%) had used all three medications, indicating that children with severe ADHD symptoms, autistic features and child-parent violence are more likely to experience all three during their treatment have been found to be more likely to experience three medications during treatment (4). Therefore, it is crucial to assess the background of ADHD symptoms and, in doing so, consider interventions for these background factors.

The 5th edition of the Guidelines for the Diagnosis and Treatment of ADHD in Children was published in 2022 (5). It recommends focusing on psychosocial treatment rather than pharmacotherapy and states that the treatment goal "should not be the complete elimination of the three main symptoms of ADHD, but rather the improvement of the vicious cycle of maladaptive conditions at school and at home with the improvement of these symptoms and the ability to accept ADHD symptoms as personality traits of individual". The goals of ADHD treatment are the development of moderate self-esteem through the acceptance of the disorder and the development of an adaptive personality based on ADHD characteristics. An appropriate psychosocial treatment should be provided on the basis of thorough understanding of these treatment goals. After providing psychosocial treatment, minimal medication should be considered.

We have experienced an inpatient treatment of a girl with ADHD who had been brought up in an abusive environment. Children that have been abused can exhibit increased hyperactivity and impulsivity, which are very similar to the primary symptoms of ADHD. Simultaneously, children with ADHD are likely to be exposed to abusive parenting, *e.g.*, harsh reprimands, because of their symptoms. As a result, they tend to show psychiatric symptoms, such as damaged self-esteem, further deterioration of impulse control, and increased aggression.

Consent for the presentation of the case was obtained from the patient and their families.

Case Report (A)

Basic characteristics

To ensure anonymity, some parts not related to the treatment were modified. For the western calendar year, the year of admission was set as X, with \pm denoting the number of years before and after.

The basic characteristics of this case are as follows: *i*) Age: 14 years old; *ii*) Sex: Female; *iii*) Main complaint: hyperactivity, impulsivity, inattention; *iv*) Medical history: No history of psychiatric illness; *v*) Family structure: A's mother was a secondary school graduate and a housewife. She suffered from dissociative disorder and depression. She had been neglected, raped, got pregnant at 15, and had an abortion. In addition, she had been arrested for using methamphetamine. She was constantly verbally abusive and violent toward A. She repeatedly cut her wrist and overeat and vomits in front of A. On the other hand, A's stepfather was a high school graduate and a carpenter; he was sometimes violent toward A. A has two younger sisters from her mother and stepfather.

Growth and current medical history

No major problems in perinatal or infantile development. There was domestic violence from the father to the mother, and parents divorced when A was 2 years old. She was first seen at our clinic in year X-8 (age 6, 1st grade). In junior high school, she stopped attending school and became violent at home. She was voluntarily admitted to our clinic in April, year X (age 14, 3rd grade junior high school).

Psychological test results: When A was 14 years old, she took the Wechsler Intelligence Scale for Children, Fourth Edition, and obtained the following scores: Full-Scale Intelligence Quotient, 124; Verbal Comprehension Index, 103; Perceptual Reasoning Index, 122; Working Memory Index, 100; and Processing Speed Index, 132.

Child and adolescent psychiatric ward: The child psychiatric ward is located in a general hospital. It is an open ward with 45 beds. It has 8 four-bed rooms and 13 private rooms for children from the upper grades of primary school to the third grade of junior high school. The children can attend school at the hospital.

Assessment and treatment plan at the time of admission: At the time of admission, there was no information regarding abuse by the stepfather and mother, or regarding the mother's difficult upbringing and mental state. We considered this to be a case of repeated maladjustment due to ADHD symptoms and difficulties in family relationships leading to the patient's non-attendance at school. The treatment plan was to provide the patient and parents with psychoeducation about ADHD and to reintegrate A into the same generational group. A female child psychiatrist became A's therapist, and a female nurse became A's charge nurse.

Pharmacotherapy: Methylphenidate hydrochloride 36 mg/day.

Treatment

Phase 1 (April – August, year X)

A spent a lot of time fussing and talking aggressively to other children she had never met before. She did not attempt to interact much with adults. Her mother refused to take her home on holidays or visit her. She continued to cope with her feelings of loneliness without acknowledging them and gradually became isolated from her friends. She always had a conflict with other children. However, she usually helped the staff in minor situations and calmed other children who were acting out in the ward. Her therapist told A that there was a good side to her and that she was repeatedly trying to deal with her negative feelings in a manic way, which was extremely hurtful. Then, A began to show signs of dependence on the therapist, such as quietly approaching her when she was anxious. A said, "I do not like girls. Girls are vulnerable and fragile. They irritate me when I see them. They are different from me". She often wore men's clothes. Once, when the therapist reported to A's mother that she was having a good time on the ward,

she expressed her rejection of A even more strongly than before. The mother told the therapist that her own mental health was very poor; she had been abused since childhood; she hated A, who had repeatedly caused her problems; and she wanted a life without A. A's mother, who had survived difficult circumstances, was unable to deal with her own childhood experiences and turned against A.

Phase 2 (August, year X – January, year X+1)

We repeatedly lost contact with A's mother, and she had refused A's temporary return for holidays and cancelled interviews without prior notice. During meetings with her therapist, A avoided important topics and instead repeated physical complaints. There was an increase in challenging behavior, such as repeatedly visiting other rooms to compete with rival girls and making noise in the corridors at night. The therapist understood that A's problematic behavior was a manifestation of her own pain, and she repeatedly told her she was concerned about her. Gradually, A began to talk more about her feelings. However, shortly after the meeting, it was decided that she would not be allowed to leave her room at night in order to deal with the problem of trespassing in other rooms. As this happened right after we had talked about confidentiality, A said, "I don't think I can talk to you anymore". She stopped talking about anything during the interview. The therapist was so preoccupied with the superficiality of the problem that she felt helpless, as if she had missed something important. In November, A was not speaking to her therapist and was continuing to lose weight. Thus, the therapist decided to increase the frequency of interviews to twice a week and give her a private room to let her know that we cared about her and wanted to protect her. When the therapist told her this, she looked relieved and nodded her head with tears in her eyes.

In December, influenced by the removal of behavioral restrictions for hostile girls in the same year, she continued leaving her room without permission and making noise in the ward at night. Her therapist repeatedly told her to communicate her feelings and thoughts to the therapist instead of expressing them through behavior, but the conversation continued with name-calling and silent confrontations that lasted dozens of minutes and exhausted even the therapist.

The ward staff discussed the issue and decided that the nurse should invite A to go for a walk every day and create opportunities for the adult and A to engage with each other. A refused, saying "walking is such a hassle, I'll never go". However, she looked happy every time she was invited.

The same situation continued in our meeting. However, she did not refuse the meeting and repeated the same exchange twice a week. A gradually began to go for walks and complain about her therapist and family only on days when the charge nurse invited her. Again,

her therapist reminded her of deadlines and commitments and urged her to stick to the rules. When the therapist praised her attitude and efforts, she looked good and confident.

Phase 3 (February – March, year X+1)

Although she continued showing problematic behaviors and experienced restrictions from her therapist on several occasions, she did not rebel as much as before. A's mother, a high school dropout and a secondary school graduate, was reluctant and critical of her support for A going to high school, but A decided to enroll in a correspondence high school and always attended the first period of her class at the hospital to practice commuting to school.

She strongly objected to the idea of all the girls dancing together in beautiful skirts at the farewell party in the hospital ward and was very insistent that she would not participate. However, through communication with the charge nurse and her therapist, she eventually decided to attend and was able to dance with a smile on her face. She even hesitated to take off the costume immediately after the party. After leaving the hospital, she went to a correspondence school and worked part-time. She sometimes forgot to go to the outpatient clinic or argued with her mother, but she found her place outside the home.

Discussion

Phase 1 (April – August, year X) included psychological treatment, which involved relationship building and understanding pathological conditions. There was a major problem in A's family: she had no experience of emotional acceptance. She had no choice but to express her negative feelings through aggression and impulsive challenging behavior. It was important for the therapist to acknowledge A's feelings and positive aspects and to present an image of women other than A's mother.

Phase 2 (August, year X – January, year X+1) included very important clinical sessions to help with acceptance and limits owing to her impulsivity and low self-esteem. When her therapist set the limits, she would violently rebel and direct her strong aggression toward her. The limits were not an attack or punishment on A but were intended to protect her from being hurt by her challenging behavior. Several studies have demonstrated that low self-esteem resulting from childhood adversity experiences has a significant impact on children's lives (6,7). A was abused by her family and, as a result, did not develop self-esteem and emotional regulation. Treatment staff continued to show A acceptance while restricting her. Thus, it was necessary for her to experience controlling her own impulsivity through interaction with treatment staff and other children in the controlled environment of the inpatient treatment. From the perspective of family therapy, the first step was to

ask the mother about her own upbringing and symptoms. The therapist told her that she also wanted to support and help her and proceeded to adjust the environment while listening to her story.

Phase 3 (February – March, year X+1) involved gaining a modified emotional experience through inpatient treatment by establishing a bilateral relationship with the attending her therapist and interacting with peers and teachers in the inpatient classrooms. A had an ambivalent attitude toward a group therapy including junior high school girls. When she was asked to dance with a group of girls at the farewell party at the end of the school year, she showed both a vehement refusal and a desire to join. A's therapist team encouraged her to participate because they felt that it was important for her to learn to accept her own female identity. She was able to work with the female staff and seemed to accept them as a female role model who were different from her mother. Eventually, she danced in her high school uniform. At the end of the meeting, she gave a great speech as a representative of the graduating class in her uniform and was discharged from the hospital in March, year X+1.

Conclusion

In this case, there was a history of impulsive challenging behavior; in addition to the ADHD symptoms, the abusive upbringing from an early age had resulted in increased aggression, psychological damage, and low self-esteem. The abusive mother was also a competitor to her and was vulnerable and unable to present a healthy femininity to her. A entered adolescence without sufficient support from her mother before puberty. The ambivalence of dependence and rebellion extremely increased, and the problem manifested as withdrawal. In the treatment, while setting limits, positive evaluations of the positive aspects were actively communicated. The staff were particularly aware of becoming a part of her ego function different from her mother. A's challenging behavior was gradually reduced, and she was able to develop the right self-image. This is a case in which the structure of the hospitalization enabled the work of limiting the patient while protecting and accepting her.

Funding: This work was supported in part by Grants-in-

Aid for Research from the National Center for Global Health and Medicine (23A 3002).

Conflict of Interest: The authors have no conflicts of interest to disclose.

References

1. Thomas R, Sanders S, Doust J, Beller E, Glasziou P. Prevalence of attention-deficit/hyperactivity disorder: A systematic review and meta-analysis. *Pediatrics*. 2015; 135:e994-e1001.
2. Retz W, Rösler M. Association of ADHD with reactive and proactive violent behavior in a forensic population. *Undefined*. 2010; 2:195-202.
3. Yu R, Aaltonen M, Branje S, Ristikari T, Meeus W, Salmela-Aro K, Goodwin GM, Fazel S. Depression and violence in adolescence and young adults: Findings from three longitudinal cohorts. *J Am Acad Child Adolesc Psychiatry*. 2017; 56:652-658.e1.
4. Sasaki Y, Tsujii N, Sasaki S, et al. Current use of attention-deficit hyperactivity disorder (ADHD) medications and clinical characteristics of child and adolescent psychiatric outpatients prescribed multiple ADHD medications in Japan. *PLoS One*. 2021; 16:e0252420.
5. Study Group on Diagnostic and Treatment Guidelines for ADHD. Guidelines for the Diagnosis and Treatment of Attention Deficit/Hyperactivity Disorder-ADHD-5th edition (Saito K, Iida J, eds.). Jiho Corporation, Tokyo, Japan, 2022. (in Japanese)
6. Kuhar M, Zager Kocjan G. Adverse childhood experiences and somatic symptoms in adulthood: A moderated mediation effects of disturbed self-organization and resilient coping. *Psychol Trauma*. 2022; 14:1288-1298.
7. Matsuura N, Hashimoto T, Toichi M. Correlations among self-esteem, aggression, adverse childhood experiences and depression in inmates of a female juvenile correctional facility in Japan. *Psychiatry Clin Neurosci*. 2009; 63:478-485.

Received April 12, 2023; Revised July 31, 2023; Accepted August 6, 2023.

Released online in J-STAGE as advance publication August 10, 2023.

**Address correspondence to:*

Masahide Usami, Department of Child and Adolescent Psychiatry, Kohnodai Hospital, National Center for Global Health and Medicine, 1-7-1 Kohnodi, Ichikawa, Chiba, Japan.
E-mail: usami.masahide@hospk.ncgm.go.jp

Pulmonary sclerosing pneumocytoma: A potential pitfall mimicking lung adenocarcinoma

Himani Rai¹, Ipsita Dhal^{1*}, Zachariah Chowdhury¹, Swapnil Patel², Durgatosh Pandey²

¹Department of Onco-pathology, Homi Bhabha Cancer Hospital and Mahamana Pandit Madan Mohan Malaviya Cancer Centre, Varanasi, India;

²Department of Surgical Oncology, Homi Bhabha Cancer Hospital and Mahamana Pandit Madan Mohan Malaviya Cancer Centre, Varanasi, India.

Abstract: Pulmonary sclerosing pneumocytoma (PSP), a rare benign lung tumor of primordial epithelial origin, commonly affects middle-aged Asian females. Diagnosis of this entity is challenging because of the non-specific radiological characteristics that resemble malignancies and its histological heterogeneity. Main differential diagnoses considered are adenocarcinoma lung and carcinoid tumor. In this case report, we discuss our experience of diagnosing a case of pulmonary sclerosing pneumocytoma, which showed increased SUV uptake in PET-CT indicating towards a malignancy and was also misdiagnosed as adenocarcinoma in CT-guided FNAC. The histology showed variable morphological features and there was a differential staining pattern of TTF1 and napsin A in the cells. We have highlighted the differential diagnosis and the challenges faced for diagnosing this benign, rare entity.

Keywords: pulmonary sclerosing pneumocytoma, adenocarcinoma, fine needle aspiration cytology

Introduction

Pulmonary sclerosing pneumocytoma (PSP) is a rare benign neoplasm, which most frequently affects middle-aged women. This entity was named "sclerosing pneumocytoma" and was moved from the "miscellaneous tumors" category to "Adenomas" in the 2015 WHO Classification of lung tumors. It is typically a benign tumor, however, lymph node recurrence, pleural and bony metastases and malignant transformation can occur very rarely. The presence of two cell types, cuboidal surface cells and stromal round cells, both of which are regarded as neoplastic, are the primary characteristic morphological features of PSP (1).

An isolated, well-circumscribed lump or tumor is the typical radiological appearance of a pulmonary sclerosing pneumocytoma. Most cases are detected as an incidental finding during routine medical examinations without any noticeable clinical symptoms. Chest tightness, coughing, and chest pain may be present in certain individuals, which may be because of lung tissue compression by an enlarged lesion (2). When the nature of the lesion cannot be determined on computed tomography (CT), the 18F-fluorodeoxyglucose positron emission tomography (FDG PET)/CT is an appropriate option. However, a larger lesion size may have more active cell proliferation, which could result in a higher uptake of the fluorodeoxyglucose 18F-FDG and be mistaken for a malignant tumor (3).

Here we discuss a case of a woman who underwent a

right lung lower lobectomy after receiving a diagnosis of lung adenocarcinoma which subsequently turned out to be PSP in detailed histological and immunohistochemical evaluation after receiving informed consent from the patient.

Case Report

A 30-year-old-female came to our emergency department with complaint of hemoptysis for 25 days. She was admitted to our hospital on September 2, 2021. She had no history of smoke exposure (either active or passive). PET-CECT was done in an outside centre, which showed a mass in the right lung lower lobe with increased SUV uptake and no other abnormal findings elsewhere.

CT guided FNAC from lung mass revealed small clusters of medium to large sized cells showing moderate pleomorphism, nuclear hyperchromasia, inconspicuous nucleoli and moderate amount of cytoplasm (Figure 1A). Cytology was reported as positive for malignancy, suggestive of non-small cell carcinoma with possibility of adenocarcinoma and histopathological examination was advised for confirmation. The outside biopsy was also reported as adenocarcinoma.

Right lower lobectomy was done and we received the surgical specimen. On gross examination, a well-defined solid lesion was identified, measuring 3.8 × 2 × 3 cm. Cut section showed variegated and hemorrhagic areas (Figure 1B). On microscopy, lower magnification demonstrated cells arranged in a papillary pattern and

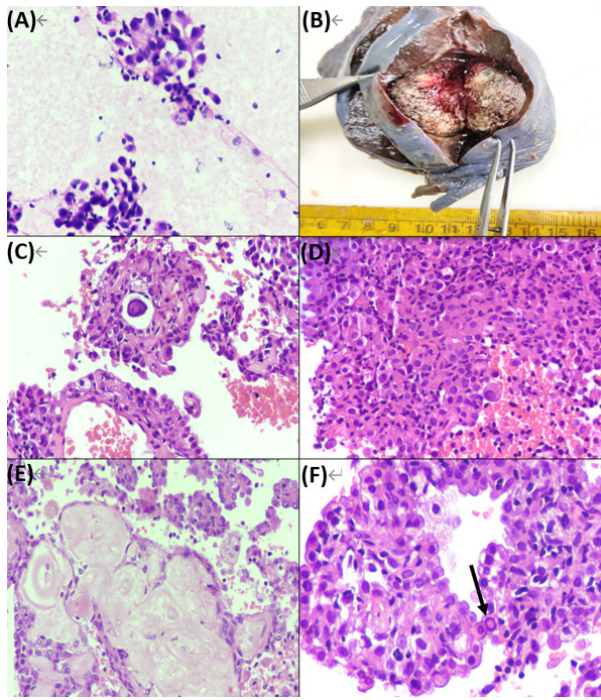

Figure 1. (A) Cyto smears showed small clusters of cells having nuclear hyperchromasia, inconspicuous nucleoli and moderate amount of cytoplasm. (B) Gross image: Cut section is variegated and shows hemorrhagic areas. (C) Histopathology shows cells arranged in papillary pattern with dual cell population: papillae are lined by cuboidal surface cells and papillary cores show round stromal cells (H&E, 40×). (D) Cells are arranged in solid sheets along with areas of hemorrhage. Cells are polygonal with abundant eosinophilic cytoplasm, oval nuclei, even chromatin, indistinct nucleoli, hyperchromasia, pleomorphism (H&E, 40×). (E) Sclerotic stroma along with foamy histiocytes (H&E, 40×). (F) Papillae are lined by cuboidal cells and papillary cores show round cells. Few cells show intranuclear inclusions (arrow).

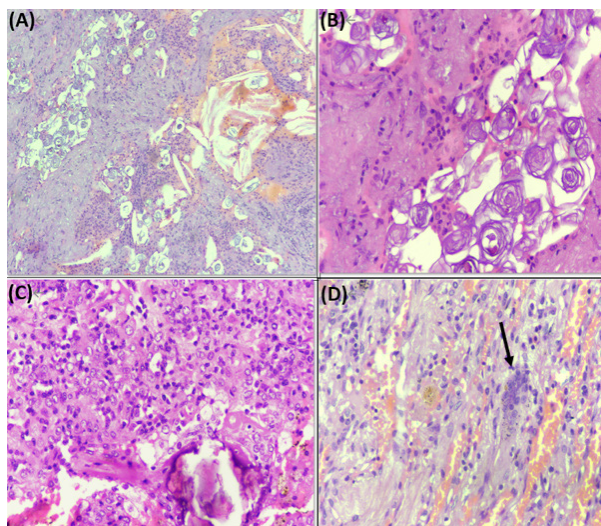

Figure 2. (A) Microsection shows cholesterol clefts along with numerous rounded lamellated structures (H&E, 20×). (B) Lamellated surfactant-like substance (H&E, 40×). (C) Areas of calcification with surrounding stromal cells exhibiting mild nuclear pleomorphism (H&E, 40×). (D) Multinucleated giant cells are seen (arrow).

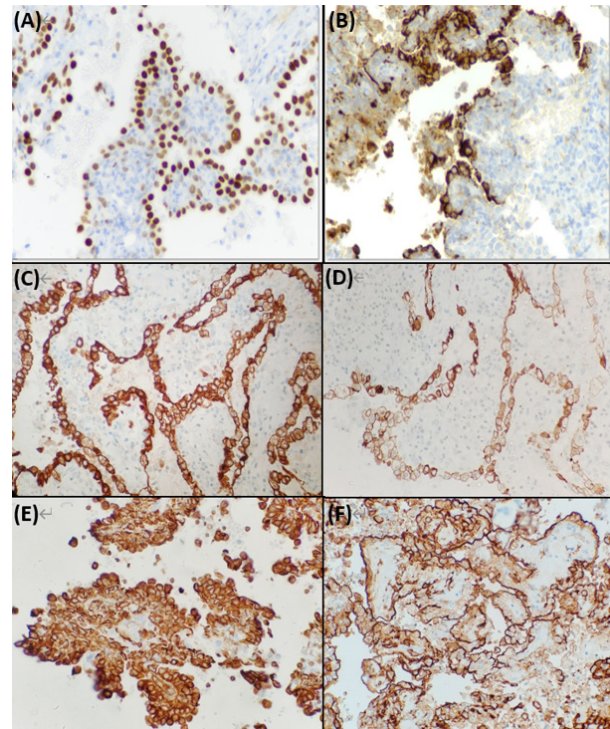

Figure 3. (A) TTF1 highlights the surface epithelial cells along with few stromal cells. (B) Surface epithelial cells show positivity to napsin A while stromal cells are negative. (C) AE1/AE3 highlights the surface epithelial cells. (D) CK7 shows positivity in surface epithelial cells while stromal cells are negative. (E) Both stromal cells and surface cells are positive for vimentin. (F) EMA highlights the surface epithelial cells and not the stromal cells. (40× magnification)

solid sheets with large areas of hemorrhage. Higher power revealed proliferation of dual cell population, comprised of surface cuboidal cells resembling type II pneumocytes lining the papillary structures, and rounded stromal cells within the papillary cores, having moderate to abundant eosinophilic to vacuolated cytoplasm, oval nuclei with mild pleomorphism, fine even chromatin, and indistinct nucleoli (Figure 1C). The stroma was sclerotic with presence of sheets of foamy histiocytes. Areas of blood lakes, hemosiderin-laden macrophages, and cholesterol clefts were noted. Numerous lamellated surfactant like structures were seen interspersed within the tumor cells. Occasional multinucleated giant cells were also identified (Figure 2).

On immunohistochemistry (IHC), a distinct pattern of staining was identified, as TTF1 was positive in both the stromal cells as well as the pneumocytes, while napsin A highlighted the pneumocytes only. Stromal cells were negative for napsinA. The surface lining cells also were positive for Pan CK, CK7, vimentin and EMA (Figure 3). Diagnosis of PSP was done and the patient was advised to follow up. The last follow up of the patient was on January 3, 2023, and she was completely symptom free except for mild headache.

Discussion

This case report demonstrates the best diagnostic procedure for a patient with a questionable radiographic and pathological finding. Because PSP is often misdiagnosed as well-differentiated lung adenocarcinoma, it is critical to recognize this entity and its significant pathological variations.

PSP should be taken into account for a young woman who has a single round to oval-shaped nodule, smooth boundaries, and strong, homogenous enhancement on contrast-enhanced CT, with or without overlaying vascular sign, halo sign, or air crescent sign. However, only 30% of enhanced CT diagnoses for PSP are accurate (2).

In general, 18F-FDG PET/CT scan results are interpreted as positive for malignancy when FDG uptake of a pulmonary nodule on qualitative assessment is greater than background mediastinal blood pool activity or when SUVmax values exceed 2.5 (4). In the present case, 18F-FDG PET/CT showed a false positive result, indicating malignancy. 44.7% of tumors are juxtapleural or juxtafissural, and the lesions are typically smaller than 30 mm in diameter and frequently situated in the periphery. It can occasionally be misinterpreted as a bronchial cyst, lung cancer, pulmonary carcinoid, pulmonary hamartoma, tuberculoma, or inflammatory nodule. Although PSP displays varied FDG accumulations, 18F-FDG PET is frequently helpful in identifying benign from malignant tumors. As compared to the asymptomatic group, PSP patients, which are symptomatic displayed a greater maximal standardised uptake value (5). The cause of this intense SUV uptake can be due to active proliferation of round cells with poor differentiation and various tumor cells (6,7). When the lesion is tiny and located peripherally, bronchoscopic diagnosis can be challenging (5).

When possible, pre-operative diagnosis is useful for determining the best course of treatment. PSP is well known for having two distinct cell populations, surface lining cells and round stromal cells, which are commonly arranged in four different architectural patterns: papillary, sclerotic, solid, and hemorrhagic. At least two of the four architectural patterns, most typically the papillary and solid patterns occur in all patients, and three of the patterns are present in 95% of patients (8). The present case has all the four described histological patterns.

Gal *et al.* were the first to note that the identification of the dual cell population, which is made up of a lot of stromal cells and few surface cells, is necessary for the cytologic diagnosis of this condition (9). Due to the rarity of the disease and possible pathologists' lack of acquaintance with its cytologic features, fine-needle aspiration (FNA) cytology is problematic since it is not always able to distinguish between the two tumor cell types. Few case reports exist that describe preoperative

cytologic and histological PSP findings, and in these studies, intraoperative frozen sections (FS), EBUS-TBNA, or computed tomography (CT)-guided FNA frequently resulted in incorrect diagnosis (7). In the present case report, also cytology report was suggestive of non-small cell carcinoma, as the cytological features were overlapping with that of lung adenocarcinoma. In any case, the cytologic heterogeneity of this tumor makes the diagnosis difficult because the smears can range from hypocellular, bloody, sclerotic to hypercellular, loaded with stromal fragments, and/or showing epithelial cell proliferation, depending on the needle biopsy sampling area (8).

Cytological features of PSP demonstrated cells arranged in cohesive papillae, clusters or flat sheets, an abundant dual population of polygonal type II pneumocytes and spindle cells. These cells have spherical, bland nuclei with inconspicuous nucleoli and an abundance of pale, eosinophilic cytoplasm. Patent intranuclear inclusions are a valuable indicator that has to be looked into and should be appreciated (10). Hyalinized stromal tissue microfragments are also seen. The absence of necrosis and mitoses, which highlight the benign nature of the tumor, is a crucial observation. If all of these important cytological quirks are seen on smears, a skilled cytopathologist can quickly determine the diagnosis (10).

However, we must remember that there are various pitfalls in the cytopathological diagnosis of PSP, because papillary pattern of arrangement of the tumor cells in PSP can mimic lepidic type well-differentiated lung adenocarcinoma, papillary thyroid gland carcinoma and mesothelioma. In these scenarios, nuclear morphology can be helpful. Round cells and typical papillary areas in cytology smears may mimic a carcinoid tumor. The key differentiating features are a monotonous population of only one cell type, that helps distinguish it from PSP. Also areas of neoplastic clear cells in cytology may be confused with renal cell carcinoma with metastases which we can be ruled out by nuclear morphology, pleomorphism and frequent mitotic figures and also with the help of proper clinical history, and radiological correlation (10).

Microscopy in PSP shows morphological heterogeneity. The surface cells line the papillae and the round cells are found inside papillary cores and can also be arranged in solid sheets. The surface cells are cuboidal in shape and few of them may have nuclear pseudoinclusions. Multinucleated cells, and foamy histiocytes are common. Stromal cells have irregular cell boundaries, oval nuclei, even chromatin, indistinct nucleoli, and are polygonal. They may also exhibit cytoplasmic vacuolization, hyperchromasia, and pleomorphism. Stroma is predominantly sclerotic, frequently exhibit areas of haemorrhage, blood lakes, histiocytic aggregates, chronic inflammation, lamellar structures (extracellular surfactant), and cholesterosis.

The present case has all these morphologic findings. Rare granulomatous reaction can also be seen and mitosis is infrequent. Angiolymphatic invasion and necrosis are absent (1).

The common differential diagnosis are well-differentiated adenocarcinoma of lung, particularly the lepidic variety, carcinoid tumor, alveolar adenomas, and lung papillary adenomas. Cellular and nuclear morphology plays a significant role in these situations. Lung adenocarcinomas, often show necrosis, irregular nuclear shapes, and higher N/C ratio. IHC analysis shows diffuse positivity of tumor cells with TTF-1 and napsin A, without a differential staining pattern like PSP. Carcinoid tumors lack the hyalinized stroma and consist of a uniform population of cells with salt and pepper nuclear chromatin. Immunohistochemical analysis shows positive staining of the tumor cells for neuroendocrine markers (INSM 1, synaptophysin and chromogranin) in all cases, and is positive for TTF-1 (1). Alveolar adenomas shows lack of the typical morphological patterns of PSP (solid, papillary, sclerotic and hemorrhagic). Also the stromal cells are negative for TTF1 in alveolar adenomas. Sclerosing pneumocytoma lacks cystic spaces and shows TTF1 positive stromal cells (1). Lung papillary adenomas are well-circumscribed papillary neoplasms composed of cuboidal to columnar cells that line the fibrovascular centres and are cytologically bland. Only the surface epithelial cells are positive for TTF1, CK7, pancytokeratin, surfactant protein, and EMA while the stromal cells are negative. In contrast, sclerosing pneumocytoma is composed of two cell types, with papillary structures containing a TTF1-positive cellular rather than a fibrovascular core and more-varied growth patterns (1).

There have been a number of reports on the malignant potential of PSP, lymph node metastases and/or local recurrence. Although these malignant potentials do not appear to have an impact on the prognosis of PSP, there are other variables that may be relevant. The common presentation in females is supposed to be due to the presence of progesterone (11).

Treatment options for this benign tumor are still debatable. The main course of treatment is surgery. For peripheral small-sized tumors, sublobectomy, most commonly segmentectomy and wedge resection are favoured. However, it has not been fully addressed as to what resection extent is ideal (11).

Few studies have reported gene mutations in PSP. AKT1, was the genetic signature of PSP. It causes cell growth and morphological changes, however, it does not cause progression to cancer. The second most frequent gene mutation in PSP is beta-catenin, which may also contribute to the development of benign tumors rather than malignant ones. In addition to AKT1 and beta-catenin, mutations in the tumor-related genes PTEN, BRAF V600E, BLM, and KMT2D were also found in

the sclerosing pneumocytoma, though at a comparatively lower frequency (11).

Conclusion

Diagnosis of pulmonary sclerosing pneumocytoma is difficult in frozen sections, small biopsies and cytology where they can be mistaken for adenocarcinoma or carcinoid tumors. These tumors have a benign clinical course and metastases are extremely rare. Surgical resection is part of the treatment for PSP, and the prognosis is favourable. There have been no reports of recurrence after surgery or death due to PSP. A critical factor in optimising the treatment strategy is the differential diagnosis of PSP from adenocarcinoma and carcinoid by characteristic round and surface cells and specific IHC staining.

Funding: None.

Conflict of Interest: The authors have no conflicts of interest to disclose.

References

1. WHO Classification of Tumor Editorial Board. Thoracic Tumors. Lyon (France): International Agency of Research on Cancer; 2021.
2. Song L, Yan P, Mo G. Sclerosing pneumocytoma: A carcinoma mimicker. *Integr Cancer Sci Ther.* 2021; 8:1-3.
3. Cheung YC, Ng SH, Chang JW, Tan CF, Huang SF, Yu CT. Histopathological and CT features of pulmonary sclerosing haemangiomas. *Clin Radiol.* 2003; 58:630-635.
4. Lim JH, Lee N, Choi DW, Oh HJ, Park HY, Kim KH, Kim TO, Park CK, Shin HJ, Choi YD, Yun JS, Song SY, Oh IJ. Pulmonary sclerosing pneumocytoma mimicking lung cancer: Case report and review of the literature. *Thorac Cancer.* 2016; 7:508-511.
5. Muto Y, Kuse N, Inomata M, Awano N, Tone M, Minami J, Takada K, Fujimoto K, Wada A, Nakao K, Furuhashi Y, Hori C, Bae Y, Kumasaka T, Izumo T. A case of pulmonary sclerosing pneumocytoma diagnosed preoperatively using transbronchial cryobiopsy. *Respir Med Case Rep.* 2021; 34:101494.
6. Lee E, Park CM, Kang KW, Goo JM, Kim MA, Paeng JC, Lee HJ, Park HS, Chung DH. 18F-FDG PET/CT features of pulmonary sclerosing hemangioma. *Acta Radiol.* 2013; 54:24-29.
7. Jiang L, Huang Y, Tang Q, Zhao Q, Li Y, Wu X, Wang H. 18F-FDG PET/CT characteristics of pulmonary sclerosing hemangioma vs. pulmonary hamartoma. *Oncol Lett.* 2018; 16:660-665.
8. Trabucco SMR, Brascia D, Cazzato G, De Iaco G, Colagrande A, Signore F, Ingravalleo G, Resta L, Marulli G. Pulmonary sclerosing pneumocytoma: A pre and intraoperative diagnostic challenge. Report of two cases and review of the literature. *Medicina (Kaunas).* 2021; 57:524.
9. Gal AA, Nassar VH, Miller JI. Cytopathologic diagnosis of pulmonary sclerosing hemangioma. *Diagn Cytopathol.* 2002; 26:163-166.

10. Onorati M, Nicola M, Bianchi CL, Bini F, Bellaviti N, Di Nuovo F. Pitfalls and key features of a case of sclerosing pneumocytoma: A cytological challenge? *Acta Cytol.* 2016; 60:85-88.
11. Zheng Q, Zhou J, Li G, Man S, Lin Z, Wang T, Chen B, Lin F. Pulmonary sclerosing pneumocytoma: Clinical features and prognosis. *World J Surg Oncol.* 2022; 20:140.

Received May 23, 2023. Revised July 27, 2023; Accepted

August 10, 2023.

Released online in J-STAGE as advance publication August 17, 2023.

**Address correspondence to:*

Ipsita Dhal, Department of Onco-pathology, Homi Bhabha Cancer Hospital and Mahamana Pandit Madan Mohan Malaviya Cancer Centre, Varanasi, Uttar Pradesh 221005, India.

E-mail: dripsitadhal@gmail.com

Global vaccine equity: The G7's commitment and challenges

Yudai Kaneda^{1,*}, Kenzo Takahashi², Akihiko Ozaki³, Tetsuya Tanimoto⁴

¹ School of Medicine, Hokkaido University, Hokkaido, Japan;

² Graduate School of Public Health, Teikyo University, Tokyo, Japan;

³ Department of Breast and Thyroid Surgery, Jyoban Hospital of Tokiwa Foundation, Fukushima, Japan;

⁴ Department of Internal Medicine, Jyoban Hospital of Tokiwa Foundation, Fukushima, Japan.

Abstract: The "Hiroshima Vision", unveiled at the G7 Hiroshima Summit in 2023, leaves room for enhancement in the specific content of equitable global vaccine distribution plans. Despite the efforts of COVID-19 Vaccines Global Access (COVAX), vaccine supply faces severe disparities, with high-income countries receiving a disproportionately larger share. To mitigate future public health crises, mechanisms proven by past instances, such as establishing regional vaccine hubs, promoting technology transfers, and considering early patent rights relinquishment, need to be implemented. Correcting vaccine inequity necessitates learning from the COVID-19 pandemic and demands global cooperation and consensus from the G7.

Keywords: G7 Hiroshima Summit, global vaccine equity, COVID-19, COVAX, Japan

G7 Hiroshima Summit, held in May, 2023, released the "Hiroshima Vision", initiating a partnership for better medical countermeasure access and delivery based on equity, efficiency, and speed principles (1). Yet, more realistic global vaccine plans should have been incorporated from the experience of the coronavirus disease 2019 (COVID-19) pandemic.

One of the lessons to be learned is the significant global disparity in vaccine supply. Although the COVID-19 Vaccines Global Access (COVAX) is a joint initiative of global health entities to equitably distribute vaccines to mitigate the health and economic impact of the pandemic, according to the latest statistics of two-dose supplies, high-income countries are supplied with 75%, while only 26% of vaccines are supplied to low-income countries (2). This was because high-income countries prioritized the vaccination of their citizens, especially the newly developed and effective mRNA vaccines failed to reach low- and middle-income countries (LMICs).

Although the number of deaths was relatively low in Africa and other countries due to younger populations compared to developed countries, continued effort to distribute mRNA vaccines, which is also effective in preventing long covid, should be explored because COVID-19 will not cease in the foreseeable future (3). Moreover, considering the increased risk from the global population aging, establishing a global vaccine hub is urgently needed, as low-income regions such as Africa may become the next endemic area (4).

However, as it is unclear to what extent the establishment of one company's vaccine production base overseas, as Pfizer is currently doing in South Africa (5), for example, will contribute to equitable vaccine distribution, one possible solution is to share the technology itself in addition to the factory, with LMICs. Previously, Sumitomo Chemical, a Japanese company, transferred its insecticide-laden mosquito net manufacturing technology license-free to stakeholders in LMICs such as Tanzania (6). Such an approach highlights the challenges and possibilities of strengthening the ecosystem through private sector involvement in global health initiatives and should also be considered in the context of this COVID-19 reflection, as well as disruptive innovation.

Additionally, the early relinquishment of patent rights for mRNA vaccines should be considered a viable solution to redress vaccine inequities. The efficacy of positioning vaccines, testing equipment, and treatments as global public goods is suggested by the World Health Organization's decision in 2005 to essentially waive the intellectual property rights to Antiretroviral drugs (ARVs) for the treatment of HIV/AIDS, to improve access to these ARVs in LMICs (7). As a result, countries like Kenya could import generic drugs through compulsory licenses, reducing the cost of ARVs. It may also be effective to encourage the relinquishment of intellectual property rights by companies like Pfizer and Moderna for mRNA vaccines under the cooperation of the G7.

Vaccines, funded heavily by public money, should not be controlled by a few entities but should be global

public assets for sustainable scaling and vaccine inequity. Intellectual property exemptions, providing regional vaccine production networks, and technology transfers can help achieve this. These approaches will require global cooperation, funding, and political will, and further discussion and G7 consensus is desired.

Funding: None.

Conflict of Interest: Dr. Ozaki reported personal fees from Medical Network Systems Inc. and Kyowa Kirin co. ltd. outside the submitted work. Dr. Tanimoto reported personal fees from Medical Network Systems Inc. and Bionics co. ltd., outside the submitted work. No other disclosures were reported.

References

1. Ministry of Foreign Affairs of Japan. G7 Hiroshima Leaders' Communiqué 2023. <https://www.mofa.go.jp/mofaj/files/100506909.pdf> (accessed May 27, 2023).
2. World Health Organization. COVAX DATA BRIEF 2023. https://www.gavi.org/sites/default/files/covid/covax/COVAX-data-brief_22.pdf (accessed May 27, 2023).
3. Byambasuren O, Stehlik P, Clark J, Alcorn K, Glasziou P. Effect of covid-19 vaccination on long covid: Systematic review. *BMJ Medicine*. 2023; 2:e000385.
4. Chang AY, Skirbekk VF, Tyrovolas S, Kassebaum NJ, Dieleman JL. Measuring population ageing: An analysis of the Global Burden of Disease Study 2017. *Lancet Public Health*. 2019; 4:e159-e167.
5. Becker Z. South Africa's Biovac produces first Pfizer COVID-19 vaccine doses: Report 2022. <https://www.fiercepharma.com/vaccines/south-africas-biovac-produces-first-pfizer-covid-19-doses-bloomberg-reports> (accessed May 27, 2023).
6. Gradl C. Sumitomo Chemical and the Fight Against Malaria Using Bednets: A Case Study. https://www.hks.harvard.edu/sites/default/files/centers/mrcbg/programs/cri/files/report_52_Sumitomo.pdf (accessed July 13, 2023).
7. UNAIDS. Using TRIPS flexibilities to improve access to HIV treatment 2015. https://www.unaids.org/sites/default/files/media_asset/JC2049_PolicyBrief_TRIPS_en_1.pdf (accessed May 27, 2023).

Received June 14, 2023; Revised July 13, 2023; Accepted July 14, 2023.

Released online in J-STAGE as advance publication July 16, 2023.

**Address correspondence to:*

Yudai Kaneda, School of Medicine, Hokkaido University, Kita15, Nishi 7, Kita-ku, Sapporo, Hokkaido 0608638, Japan.
E-mail: nature271828@gmail.com



Information for Authors

1. Scope of Articles

GHM Open (Print ISSN 2436-293X, Online ISSN 2436-2956) is an international, open-access, peer-reviewed journal dedicated to publishing high-quality original research that contributes to advancing global health and medicine, with the goal of creating a global information network for global health, basic science as well as clinical science oriented for clinical application.

We encourage submission of original research findings in the fields of global health, public health, and health care delivery as well as the seminal and latest research on the intersection of biomedical science and clinical practice.

2. Types of Articles

Types of Articles	Words in length (excluding references)	Figures and/or Tables	References
Original Articles	~5,000	~10	~50
Brief Reports	~3,000	~5	~30
Reviews	~8,000	~10	~100
Mini reviews	~4,000	~5	~50
Policy Forum articles	~3,000	~5	~30
Study Protocols	~5,000	~10	~50
Case Reports	~3,000	~5	~30
Communications	~2,000	~2	~20
Perspectives			
Comments			
Correspondence			
Editorials	~1,000	~1	~10
Letters	~1,000	~1	~10
News	~800	~1	~5

Abstract: ~250 words (Original Articles, Brief Reports, Reviews, Policy Forum, Study Protocols, Case Reports); ~150 words (Communications, Editorials, Letters, and News)

Keywords: 3-6 words

Original Articles should be well-documented, novel, and significant to the field as a whole. They should include an abstract and be structured as follows: Title page, Abstract, Introduction, Materials and Methods, Results, Discussion, Acknowledgments, References, Figures and/or Tables; and Supplementary Data, if appropriate. Original articles should not exceed 5,000 words in length (excluding references) and should be limited to a maximum of 50 references. Articles may contain a maximum of 10 figures and/or tables. Supplementary Data are permitted but should be limited to information that is not essential to the general understanding of the research presented in the main text, such as unaltered blots and source data as well as other file types.

Brief Reports definitively documenting either experimental results or informative clinical observations will be considered for publication in this category. Brief Reports are not intended for publication of incomplete or preliminary findings. Brief Reports should not exceed 3,000 words in length (excluding references) and should be limited to a

maximum of 5 figures and/or tables and 30 references. Brief Reports should be structured as follows: Title page, Abstract, Introduction, Materials and Methods, Results and Discussion, Acknowledgments, References, Figures and/or Tables; and Supplementary Data, if appropriate.

Reviews should present a full and up-to-date account of recent developments within an area of research. Normally, reviews should not exceed 8,000 words in length (excluding references) and should be limited to a maximum of 100 references and up to 10 figures and/or tables. Mini reviews are also accepted, which should not exceed 4,000 words in length (excluding references), have no more than 50 references, and have up to 5 figures and/or tables.

Policy Forum articles discuss research and policy issues in areas related to global health and medicine, such as public health, medical care, and social science that may address governmental issues at district, national, and international levels of discourse. Policy Forum articles should not exceed 3,000 words in length (excluding references), have no more than 30 references, and have up to 5 figures and/or tables.

Study Protocols should be the manuscripts report proposed or ongoing prospective research. Preference will be given to submissions describing long-term studies and those likely to generate a considerable amount of outcome data. Trial registration details should be stated in the manuscript, if appropriate. Study Protocols should not exceed 5,000 words in length (excluding references) and should be limited to a maximum of 10 figures and/or tables and 50 references.

Case Reports should be detailed reports of the symptoms, signs, diagnosis, treatment, and follow-up of an individual patient. Case reports may contain a demographic profile of the patient but usually describe an unusual or novel occurrence. Unreported or unusual side effects or adverse interactions involving medications will also be considered. Case Reports should not exceed 3,000 words in length (excluding references) and should be limited to a maximum of 5 figures and/or tables and 30 references.

Communications are short, timely pieces that spotlight new research findings or policy issues of interest to the field of global health and medical practice that are of immediate importance. Depending on their content, Communications will be published as "Perspectives", "Comments", or "Correspondence". Communications should not exceed 2,000 words in length (excluding references), have no more than 20 references, and have up to 2 figures and/or tables.

Editorials are short, invited opinion pieces that discuss an issue of immediate importance to the fields of global health, medical practice, and basic science oriented for clinical application. Editorials should not exceed 1,000 words in length (excluding references), have no more than 10 references, and have one figure or table.

Letters are articles that provide readers with an opportunity to respond to an article published in *GHM Open* within the previous two months or to raise issues of general interest to our readers. Letters should provide new information or insights. If appropriate, letters are sent to the authors of the article in question for a response. Letters should not exceed 1,000 words in length (excluding references), have no more than 10 references, and have one figure or table.

News articles should report the latest events in health sciences and medical research from around the world. News should not exceed 800 words in length (excluding references), have no more than 5 references, and have one figure or table.

3. Formatting Guidelines

Manuscripts should be written in clear, grammatically correct English and submitted as a Microsoft Word file in a single-column format. Manuscripts must be paginated and typed in 12-point Times New Roman font with 24-point line spacing. Please do not embed figures in the text. Technical terms should be defined. Abbreviations should be used as little as possible and should be explained at first mention unless the term is a well-known abbreviation (e.g. DNA). Single words should not be abbreviated. Please include page numbers in your submitted file. We also encourage use of line numbers.

The submission to *GHM Open* should include:

1. Cover letter
2. Submission Checklist
3. Main Manuscript (including Tables)
4. Figures
5. Supplementary Data (e.g. Supplementary Tables/Figures), if appropriate

The main manuscripts should be assembled in the following order:

1. Title page
2. Abstract
3. Main Text
4. Acknowledgments
5. References
6. Tables
7. Figure Legend
8. List of Supplementary Data, if appropriate

For manuscript samples, please visit <https://www.ghmopen.com/site/download.html> (Download Center).

Please provide all figures as separate files in an acceptable format (TIFF or JPEG). Supplementary Data should also be submitted as a single separate file in Microsoft Word format.

An abstract is necessary for all types of articles. An Original Article should be structured as follows: Title page, Abstract, Introduction, Materials and Methods, Results, Discussion, Acknowledgments, References, Figures and/or Tables; and Supplementary Data, if appropriate. A Brief Report contains the same sections as an Original Article, but the Results and Discussion sections should be combined. For manuscripts that are Reviews, Policy Forum, Study Protocols, Case Reports, Communication, Editorials, Letters, or News, subheadings should be used for increased clarity.

4. Manuscript Preparation

Title page: The title page must include 1) the title of the paper (Please note the title should be short, informative, and contain the major key words); 2) full name(s) and affiliation(s) of the author(s), 3) abbreviated names of the author(s), 4) full name, mailing address, telephone/fax numbers, and e-mail address of the corresponding author.

Abstract: The abstract should briefly state the purpose of the study, methods, main findings, and conclusions. For articles that are Original Articles, Brief Reports, Reviews, Policy Forum, Study Protocols, or Case Reports, a one-paragraph abstract consisting of no more than 250 words must be included in the manuscript. For Communications, Editorials, Letters, and News, a one-paragraph brief summary of the main content in 150 words or less should be included in the manuscript. Abbreviations must be kept to a minimum and non-standard abbreviations should be explained in brackets

at first mention. References should be avoided in the abstract. Three to six key words or phrases that do not occur in the title should be included on the Abstract page.

Introduction: The introduction should provide sufficient background information to make the article intelligible to readers in other disciplines and sufficient context clarifying the significance of the experimental findings.

Materials and Methods: The description should be brief but with sufficient detail to enable others to reproduce the experiments. Procedures that have been published previously should not be described in detail but appropriate references should simply be cited. Only new and significant modifications of previously published procedures require complete description. Names of products and manufacturers with their locations (city and state/country) should be given and sources of animals and cell lines should always be indicated. All clinical investigations must have been conducted in accordance with Declaration of Helsinki principles. All human and animal studies must have been approved by the appropriate institutional review board(s) and a specific declaration of approval must be made within this section.

Results: The description of the experimental results should be succinct but in sufficient detail to allow the experiments to be analyzed and interpreted by an independent reader. If necessary, subheadings may be used for an orderly presentation. Two levels of subheadings may be used if warranted, please distinguish them clearly. All Figures and Tables should be cited in order, including those in the Supplementary Data.

Discussion: The data should be interpreted concisely without repeating material already presented in the Results section. Speculation is permissible, but it must be well-founded, and discussion of the wider implications of the findings is encouraged. Conclusions derived from the study should be included in this section.

Acknowledgments: People who contributed to the work but do not meet the criteria for authors should be listed along with their contributions in the Acknowledgments section.

Funding: All funding sources should be credited in the Funding section. If no funding sources need be credited, please state "None".

Conflict of Interest: If you have an actual or potential conflict of interest to disclose, it must be listed; if no conflict of interest exists for each author, please state "The authors have no conflicts of interest to disclose".

References: References should be numbered in the order in which they appear in the text. Two references are cited separated by a comma, with no space, for example (1,2). Three or more consecutive references are given as a range with an en rule, for example (1-3). Citing of unpublished results, personal communications, conference abstracts, and theses in the reference list is not recommended but these sources may be mentioned in the text. In the reference list, cite the names of all authors when there are fifteen or fewer authors; if there are sixteen or more authors, list the first three followed by *et al.* Names of journals should be abbreviated in the style used in PubMed. Authors are responsible for the accuracy of the references.

Examples are given below:

Example 1 (Sample journal reference):

Mitsuya H, Kokudo N. Focusing on global health and medicine. *Glob Health Med.* 2019; 1:1-2.

Example 2 (Sample journal reference with more than 15 authors):

Hayakawa K, Kutsuna S, Kawamata T, *et al.* SARS-CoV-2 infection among returnees on charter flights to Japan from Hubei, China: a report from National Center for Global Health and Medicine. *Glob Health Med.* 2020; 2:107-111.

Example 3 (Sample book reference):

Shalev AY. Post-traumatic stress disorder: Diagnosis, history and life course. In: Post-traumatic Stress Disorder, Diagnosis, Management and Treatment (Nutt DJ, Davidson JR, Zohar J, eds.). Martin Dunitz, London, UK, 2000; pp. 1-15.

Example 4 (Sample web page reference):

World Health Organization. The World Health Report 2008 – primary health care: Now more than ever. http://www.who.int/whr/2008/whr08_en.pdf (accessed March 20, 2021).

Tables: All tables should be prepared in Microsoft Word and should be arranged at the end of the manuscript after the References section. Please note that tables should not be in image format. All tables should have a concise title and should be numbered consecutively with Arabic numerals. Every vertical column should have a heading, consisting of a title with the unit of measure in parentheses. If necessary, additional information should be given below the table.

Figure Legend: The figure legend should be typed on a separate page of the main manuscript and should include a short title and explanation. The legend should be concise but comprehensive and should be understood without referring to the text. Symbols used in figures must be explained. Any individually labeled figure parts or panels (A, B, *etc.*) should be specifically described by part name within the legend.

Figure Preparation: All figures should be clear and cited in numerical order in the text. Figures must fit in a one- or two-column format on the journal page: 8.3 cm (3.3 in.) wide for a single column, 17.3 cm (6.8 in.) wide for a double column; maximum height: 24.0 cm (9.5 in.). Please make sure that the symbols and numbers appearing in the figures are clear. Please make sure that artwork files are in an acceptable format (TIFF or JPEG) at minimum resolution (600 dpi for illustrations, graphs, and annotated artwork, and 300 dpi for micrographs and photographs). Please provide all figures as separate files. Please note that low-resolution images are one of the leading causes of article resubmission and scheduling delays.

Units and Symbols: Units and symbols conforming to the International System of Units (SI) should be used for physicochemical quantities. Solidus notation (*e.g.* mg/kg, mg/mL, mol/mm²/min) should be used. Please refer to the SI Guide www.bipm.org/en/si/ for standard units.

Supplemental Data: Supplemental data might help to support and enhance your manuscript. *GHM Open* accepts the submission of these materials, which will be only published online alongside the electronic version of your article. Supplemental files (figures, tables, and other text materials) should be prepared according to the above guidelines, numbered in Arabic numerals (*e.g.*, Figure S1, Figure S2, and Table S1, Table S2), and referred to in the text. All figures and tables should have titles and legends. All figure legends, tables and supplemental text materials should be placed at the end of the paper. Please note all of these supplemental data should be provided at the time of initial submission and note that the editors reserve the right to limit the size and length of Supplemental Data.

5. Cover Letter

The manuscript must be accompanied by a cover letter prepared by the corresponding author on behalf of all authors. The letter should indicate the basic findings of the work and their significance. The letter should also include a statement affirming that all authors concur with the submission and that the material submitted for publication has not been published previously or is not under consideration for publication elsewhere. For example of Cover Letter, please visit: Download Centre. (<https://www.ghmopen.com/site/download.html>).

6. Submission Checklist

The Submission Checklist will be useful during the final checking of a manuscript prior to sending it to *GHM Open* for review. Please visit Download Centre and download the Submission Checklist file.

7. Online Submission

Manuscripts should be submitted to *GHM Open* online at <https://www.ghmopen.com/site/login.html>. If for any reason you are unable to submit a file online, please contact the Editorial Office by e-mail at office@ghmopen.com

8. Editorial Policies

For publishing and ethical standards, *GHM Open* follows the Recommendations for the Conduct, Reporting, Editing, and Publication of Scholarly Work in Medical Journals (<http://www.icmje.org/recommendations>) issued by the International Committee of Medical Journal Editors (ICMJE), and the Principles of Transparency and Best Practice in Scholarly Publishing (<https://doaj.org/bestpractice>) jointly issued by the Committee on Publication Ethics (COPE), the Directory of Open Access Journals (DOAJ), the Open Access Scholarly Publishers Association (OASPA), and the World Association of Medical Editors (WAME).

GHM Open will perform an especially prompt review to encourage innovative work. All original research will be subjected to a rigorous standard of peer review and will be edited by experienced copy editors to the highest standards.

The publishing is supported by the International Research and Cooperation Association for Bio & Socio-Sciences Advancement (IRCA-BSSA) Group Journals. The editorial office comprises a range of experienced individuals, including managing editor, editorial associates, software specialists, and administrative coordinators to provide a smooth service for authors and reviewers.

Ethics: *GHM Open* requires that authors of studies involving humans or animals to indicate that those studies were formally approved by a relevant ethics committee or review board. For research involving human experiments, a statement that the participants gave informed consent before taking part (or a statement that it was not required and why) should be indicated. Authors should also state that the study conformed to the provisions of the Declaration of Helsinki (as revised in 2013). When reporting experiments on animals, authors should indicate whether the institutional and national guide for the care and use of laboratory animals was followed.

Conflict of Interest: All authors are required to disclose any actual or potential conflict of interest, including financial interests or relationships with other people or organizations that might raise questions of bias in the work reported. If no conflict of interest exists for each author, please state "The

authors have no conflicts of interest to disclose".

Submission Declaration: When a manuscript is considered for submission to *GHM Open*, the authors should confirm that 1) no part of this manuscript is currently under consideration for publication elsewhere; 2) this manuscript does not contain the same information in whole or in part in manuscripts that have been published, accepted, or are under review elsewhere, except in the form of an abstract, a letter to the editor, or part of a published lecture or academic thesis; 3) authorization for publication has been obtained from the authors' employer or institution; and 4) all contributing authors have agreed to submit this manuscript.

Copyright: Before a manuscript is accepted for publication in *GHM Open*, the transfer of copyright is necessary. A JOURNAL PUBLISHING AGREEMENT (JPA) form will be e-mailed to the authors by the Editorial Office and must be returned by the authors by mail, fax, or as a scan. Only forms with a hand-written signature from the corresponding author are accepted. This copyright will ensure the widest possible dissemination of information. Please note that the manuscript will not proceed to the next step in publication until the JPA Form is received. In addition, if excerpts from other copyrighted works are included, the author(s) must obtain written permission from the copyright owners and credit the source(s) in the article.

Peer review: *GHM Open* uses single-blind peer review, which means that reviewers know the names of the authors, but the authors do not know who reviewed their manuscript. The external peer review is performed for research articles by at least two reviewers, and sometimes the opinions of more reviewers are sought. Peer reviewers are selected based on their expertise and ability to provide high quality, constructive, and fair reviews. For research manuscripts, the editors may, in addition, seek the opinion of a statistical reviewer. Consideration for publication is based on the article's originality, novelty, and scientific soundness, and the appropriateness of its analysis.

Suggested Reviewers: A list of up to 3 reviewers who are qualified to assess the scientific merit of the study is welcomed. Reviewer information including names, affiliations, addresses, and e-mail addresses should be provided at the same time the manuscript is submitted online. Please do not suggest reviewers with known conflicts of interest, including participants or anyone with a stake in the proposed research; anyone from the same institution; former students, advisors, or research collaborators (within the last three years); or close personal contacts. Please note that the Editor-in-Chief may accept one or more of the proposed reviewers or request a review by other qualified persons.

Language Editing: Manuscripts prepared by authors whose native language is not English should have their work proofread by a native English speaker before submission. If not, this might delay the publication of your manuscript in *GHM Open*.

9. Accepted Manuscripts

Proofs: Galley proofs in PDF format will be e-mailed to the corresponding author. Corrections must be returned to the editor (office@ghmopen.com) within 3 working days.

Offprints: Authors will be provided with electronic offprints of their article. Paper offprints can be ordered at prices quoted on the order form that accompanies the proofs.

Article-processing Charges: The open-access policy of *GHM Open* will allow all readers from the medical and scientific community to freely utilize material published in the journal. To achieve open access, article-processing charges (\$150 per page for black & white pages, \$300 per page for color pages) will be levied for manuscripts accepted for publication in *GHM Open*. In exceptional circumstances, the author(s) may apply to the editorial office for a waiver of the publication charges at the time of submission. All invited articles are free of charge.

Article-processing charges pay for: Immediate, worldwide open access to the full article text; Preparation in various formats for print & online publication; Inclusion in global important platforms, enabling electronic citation in other journals that are available electronically.

Misconduct: *GHM Open* takes seriously all allegations of potential misconduct and adheres to the ICMJE Guideline (<http://www.icmje.org/recommendations>) and COPE Guideline (http://publicationethics.org/files/Code_of_conduct_for_journal_editors.pdf). In cases of suspected research or publication misconduct, it may be necessary for the Editor or Publisher to contact and share submission details with third parties including authors' institutions and ethics committees. The corrections, retractions, or editorial expressions of concern will be performed in line with above guidelines.

(As of January 2022)

GHM Open

National Center for Global Health and Medicine,
1-21-1 Toyama Shinjuku-ku, Tokyo 162-8655, Japan
URL: www.ghmopen.com
E-mail: office@ghmopen.com

Print ISSN: 2436-293X Online ISSN: 2436-2956



GHM Open

Global Health & Medicine Open

Volume 1, Number 1
August, 2021



www.ghmopen.com